

BLÜCHER® Marine

Product catalogue for marine pipes and drains



BLÜCHER®

K E E P I N G U P T H E F L O W

STAINLESS STEEL DRAINAGE SYSTEMS

Representatives

BLÜCHER is represented by local specialists within marine applications around the World.
If a local specialist for your area is not listed below, please contact our HQ Marine Sales.



Country	Representative	Country	Representative
Argentina	Ferreyra & Asociados S.H.	Japan	Harada Corporation
Australia	Marine Plant Systems Pty. Ltd	Netherlands	Nicoverken Marine Services B.V.
Brazil	Rui Neiva Representacoes LtdaChile	Poland	Altro Shipping Co. Ltd
Chile	Maquinarias & Inv. Tecnicas S.A.	Romania	Danube Rainbow Ltd
China	TECWAY International (Marine) Ltd	Russia	North West Services
Croatia	CROCON d.o.o	Singapore	Technique Marine Services Pte Ltd
Finland	Polarputki OY	South Korea	Jets Korea
Germany	VIRTUS GmbH	South Korea	Kyung Kook International Corp.
Greece	EPE S.A.	Spain	Pasch Y Cia S.A.
India	Hi-Point Services (I) Pvt. Ltd	Taiwan	Union Group
Italy	Stelio Bardi SRL	Turkey	Dop & Envac Ltd
		Vietnam	MTS International JSC

HQ Marine Sales - Denmark: Tel.: +45 99 92 08 00 . marine@blucher.com

Approved drainage solutions for marine



BLÜCHER® EuroPipe is a complete stainless steel sanitary pipework system approved for installation in ships. It is the natural choice of the shipbuilding industry when looking for safe, lightweight, easy-to-install and low-maintenance solutions.

The push-fit joint is completely interchangeable between either gravity or vacuum discharge systems. In addition to sanitary discharge it is also suitable for central vacuum cleaning systems, garbage disposal systems, etc. The benefits of being able to use the same pipework system throughout the vessel, regardless of the type of system employed, can offer significant installation savings.

The advantages at a glance:

- All in stainless steel
- Available in OD 50, 75, 110, 125, 160 and 200 mm in standard lengths from 0,15 to 6 metres
- Fast and simple installation due to push-fit socket and spigot end jointing
- Easily combined with other pipe materials
- Low weight of material and only 1-1,50 mm wall thickness
- Completely interchangeable between vacuum and gravity installations



BLÜCHER® Drain Marine have been developed in conjunction with leading shipyards worldwide. As a result, the product offering meets the specific demands of each individual installation regardless of the deck construction. All BLÜCHER® Marine drains are suitable for welding in the deck, can be fitted with a removable water trap (providing full rodding access from above) and are available to suit any deck finish. The advantages at a glance:

- All in stainless steel
- Modular system providing numerous possible combinations
- Multi-adjustable
- A solution for any deck finish
- Removable water trap providing efficient water seal and easy rodding access from above
- Protective cover on all lower parts



BLÜCHER® Channel stainless steel drainage channels are modular deck drainage solutions for use in galleys, pantries, door openings, outside deck areas, etc. Drainage channels are available to suit all deck finishes with a range of gratings developed to suit the varying load-bearing and flow demands. Outlets are available with a removable water trap and where applicable a filter basket to prevent solids discharging into the drainage system. Customised components are available on request.

- All in stainless steel
- Modular system providing numerous possible combinations
- Multi-adjustable
- Excellent flow and self-cleansing properties
- Perfect hygiene
- Wide range of gratings
- **Separate product catalogue available on request.**



Safe Solutions for Marine

Since the early 1980's, BLÜCHER's sanitary discharge system for marine applications has been the first-choice sanitary discharge system for newbuilding and refitting of ships in Denmark, quickly followed by leading shipyards world-wide.

To date BLÜCHER® sanitary discharge system has been installed in more than 1000 vessels worldwide ranging from cruise liners, luxury yachts and ferries to merchant ships, naval vessels and off-shore facilities. BLÜCHER is the preferred supplier to several of the largest shipyards worldwide, among them Meyer Werft GmbH, Fincantieri, STX Europe France, STX Europe Finland, Daewoo.

Sanitary Discharge Systems

The BLÜCHER® sanitary discharge system is a modular system providing numerous possible combinations and a solution for any deck or bulkhead construction. In addition to the extensive standard product range, BLÜCHER also offers purpose-made items on request to ensure that any drainage requirement can be satisfied.

All BLÜCHER® drainage products are made in stainless steel grade AISI 316L or optionally grade AISI 304. In some products, in which part components are used that are not exposed to sewage water and consequently not affecting the functionality or lifetime of the product, these part components may be made from other materials or alloys than specified for the complete products. The stainless steel material is ideally suitable for high-quality drainage systems:

- Fire resistant
- High strength - low weight
- Environmentally friendly

Furthermore it is corrosion resistant, resistant, resistant to impacts and thermal stress and hardly any maintenance is required.

In the BLÜCHER® drainage products these inherent qualities of stainless steel are enhanced by careful product design, thus resulting in:

- Long product life expectancy
- Excellent hygienic properties
- Ease of installation
- Whole-life cost advantages
- Excellent flow capacities

All penetrations are fire-tested and approved according to IMO Res. A 754(18).

All BLÜCHER® products are chemically descaled and passivated in order to enhance the natural corrosion resistance and provide a uniform matt-silver surface finish.

All stainless steel components are manufactured largely from recycled materials and are 100% recyclable.

Danish Design and production

Founded in Denmark in 1965, BLÜCHER has developed into a leading manufacturer of stainless steel drainage systems. Today, BLÜCHER is an international company and with subsidiaries and representations worldwide. The BLÜCHER Group employs more than 350 staff worldwide.

Customers all over the world appreciate our know-how, dedicated service and common sense.

Through quality stainless steel products and drainage solutions that lead waste water away, BLÜCHER is committed to the promise of keeping up the flow.

The BLÜCHER® drainage products are manufactured in Denmark using the most modern production methods and in accordance with the internationally recognised quality standard ISO 9001. Furthermore, the most respected classification societies endorse the BLÜCHER® drainage products worldwide.



More than 1000 vessels delivered since 1982

Cruise Liners & Ferries

Strandfaraskib
Costa
Brittany Ferries
Color Line
Birka Line
NCL
NCL
NCL
RCCL
Costa
Norfolk Line
NCL
NCL
AIDA Cruises
RCCL
Celebrity Cruises
Celebrity Cruises
RCCL
RCCL

Naval vessels

Greek Navy
Dutch Navy
British Navy
Danish Navy
Norwegian Navy
Argentine Navy
South Korean Navy
Norwegian Navy
BA-e design

Commercial vessels

OPDR
Zim Integrated Shipp.
Evergreen
RAL
Maersk
Buttner
Maersk

Luxury yachts

Luxury yacht
Luxury yacht
Luxury yacht
Luxury yacht
Luxury yacht
Luxury yacht
Luxury yacht
Luxury yacht
Luxury yacht
Luxury yacht
Luxury yacht
Luxury yacht
Luxury yacht
Luxury yacht

Offshore

Tidewater
Petrobras
Sevan 650
A.P. Møller - Maersk
BP
Burbon Offshore

Smyril
Costa Magica
Pont-Aven
Color Fantasy
Birka Paradise
Pride of America
Norwegian Jewel
Pride of Hawaii
Freedom of the Seas
Costa Concordia
Maersk Dover
Norwegian Pearl
Norwegian Gem
AIDA Diva
Liberty of the Seas
Celebrity Solstice
Celebrity Equinox
Oasis of the Seas
Allure of the Seas

4 gun boats
2 survey vessels
Axuillary vessel
2 logistics vessels
5 frigates
Frigate Libertad
Aprx. 35 PKX-navy vessels
Frigate
2 aircraft carriers

12 700 TEU Container
20 Container ship
10 Container ship
Container Vessel
3 Vehicle Carrier
2 Product Tanker
6 Container Vessel

Platinum
MY Pelorus
Oceanco
MY Marlin
Lady Haya
MY Turmoil
Private
Private
MS Caravelle
MY Nemo
Private
MY Shark
MY Safari
Swift 135 + 141

Hull 1674/10
Hull P54
Hull N111
Hull 151
Thunderhorse
Hull DH1004

Izar
Fincantieri
Meyer Werft
STX Europe
STX Europe
Lloyd Werft
Meyer Werft
Meyer Werft
STX Europe
Fincantieri
Samsung
Meyer Werft
Meyer Werft
Meyer Werft
STX Europe
Meyer Werft
Meyer Werft
STX Europe
STX Europe

Hellenic Shipyard
Schelde
BAE
Odense Stålskibsværft
IZAR
Argentine Navy - refit
Hanjin Shipyard
Navantia
UK Carrier Alliance

Mawei Shipyard
Dalian New Shipbuilding
MHI Japan
Remontowa
Daewoo
3. Maj Shipyard
Odense Stålskibsværft

Dubai Ports Authority
Lürssen Kröger Werft
Kusch Yacht Agentur
Lürssen Kröger Werft
Pesaro
Assens Shipyard
Azimut-Benetti
CRN
Jade Yachts
Lürssen Kröger Werft
Perini Navi
Lürssen Kröger Werft
Blohm + Voss
Abu Dhabi

Remontowa
Enaval/Mava/Jurong
Cosco (Nantong) Shipyard
Asenav
Daewoo
Zhejiang Shipyard

Approvals and certificates

BLÜCHER sanitary discharge system holds the MED Certification and type approvals of leading classification authorities

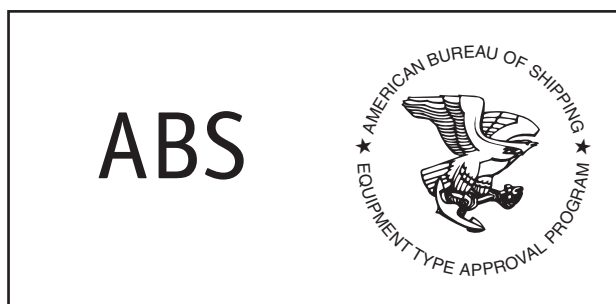



BLÜCHER® DRAIN MARINE

Presentation of marine drains.	1
Marine drains for tiled floors and steel decks.	4
Marine lower parts for steel decks.	5
Presentation of products for aluminium decks and bulkheads.	7
Marine lower parts for aluminium decks.	8
Marine upper parts for tiled and wooden floors.	9
Marine upper parts for resin floors.	10
Marine upper parts for vinyl floors.	11
Accessories for marine drains.	12
Presentation of channels and kitchen channels.	17



BLÜCHER® EUROPIPE

Presentation of BLÜCHER® EuroPipe - pipe and fittings.	19
Pipes.	24
Fittings - Bends.	26
Fittings - Branches.	28
Fittings - Sockets.	30
Fittings - Increases and reducers.	31
Fittings - Adaptors.	32
Fittings - Toilet adaptors.	34
Fittings - Others.	35
Accessories.	36
Penetrations for steel decks and bulkheads.	40
Penetrations for aluminium decks and bulkheads.	43
Presentation of jointing unit.	44
Jointing unit for steel decks and bulkheads.	45
Pipe cutters and other tools.	46

Technical information

Information about material and maintenance.	47
---	----



Drains for marine applications



Multi-adjustable For any deck finish Modular system

Applications

- Showers, toilets, wet cabins, galleys, pantries, deck areas and workshop areas
- Cruise liners, yachts, commercial vessels, navy vessels and off-shore

Details

- Protective cover on all lower parts
- Matt-polished surface
- Low 6mm frame height
- Grate with screw lock
- Stainless steel AISI 316L/EN1.4404

Variants

- Side inlets
- Vertical or horizontal outlet
- With or without welding sleeve

Options

- Removable water trap
- Design gratings available

Series

- Series 47X for stainless steel deck
- Series 48X for aluminium deck

Complete drains

Upper parts

Lower parts

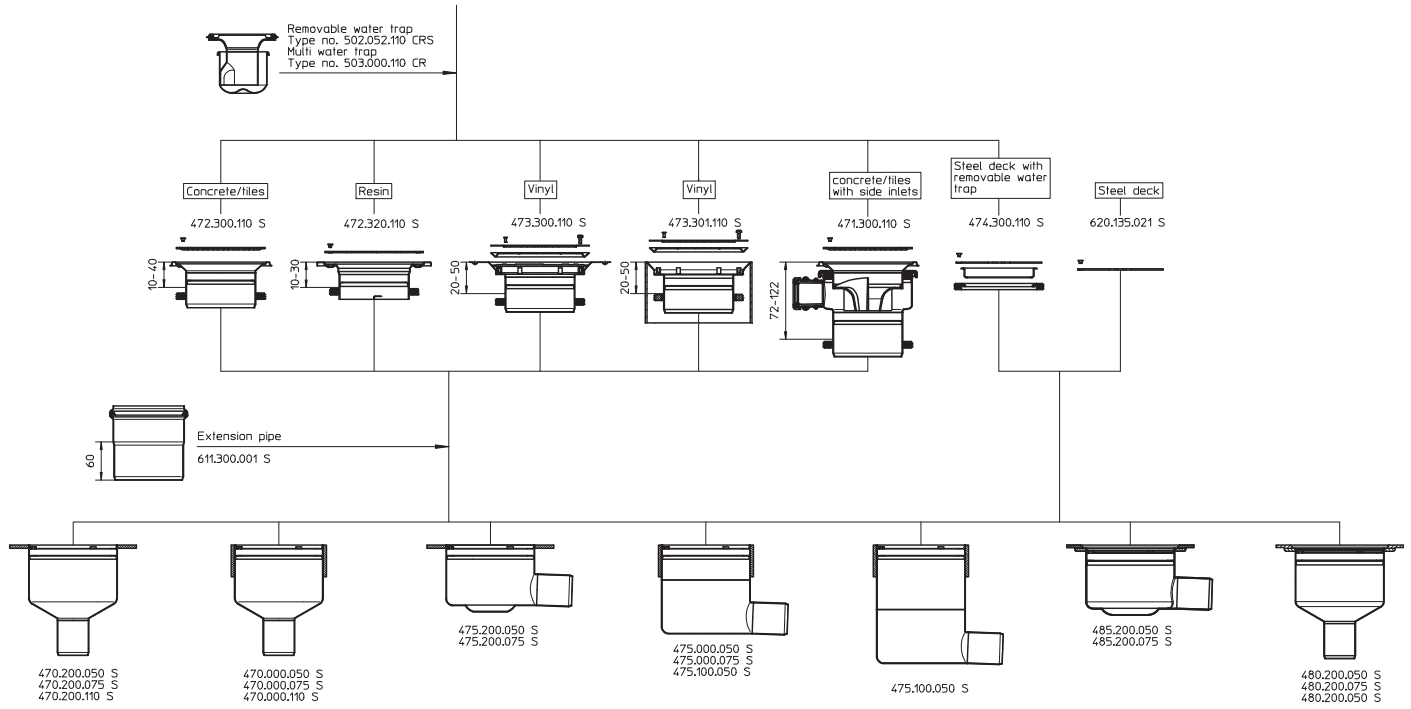

Installation examples

Tiled deck incl. water trap

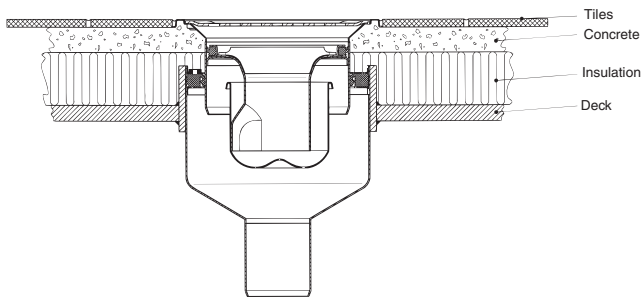

Tiled deck incl. water trap and extension pipe

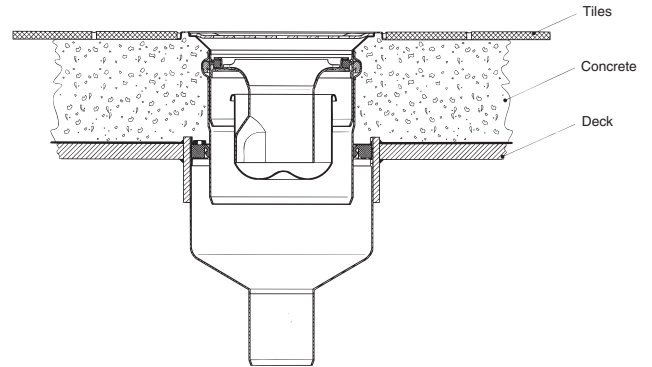

Tiled deck incl. water trap and side inlets

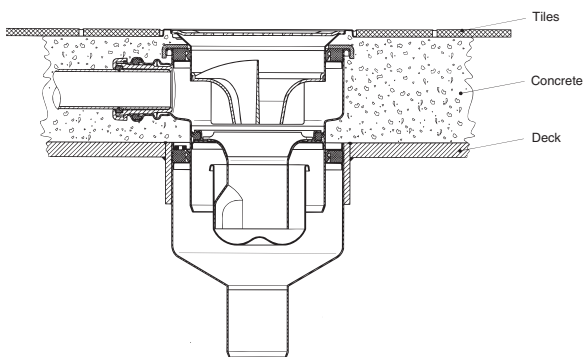

Vinyl deck incl. water trap

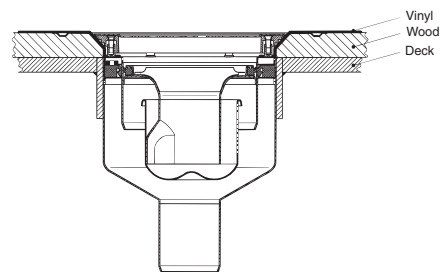

Steel deck

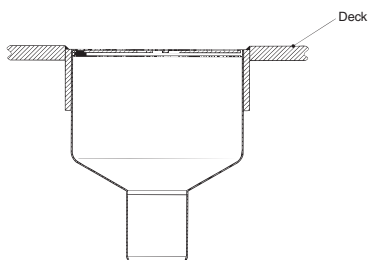

Aluminium deck

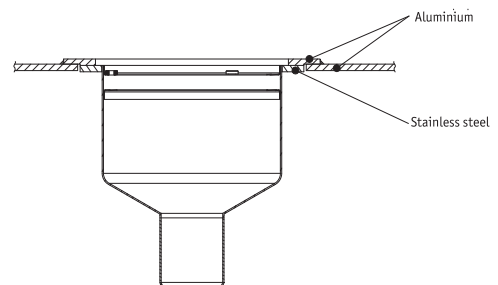

MARINE DRAIN TYPE 491
WITH REMOVABLE WATER TRAP

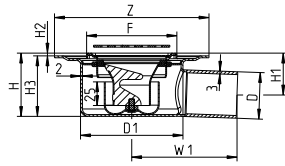

Type no.	EAN no.	D	D1	F	Z	H	H1	H2	H3	W1
491.200.050 VS	5705499131857	50	110	97x97	Ø166	68-78	45-55	3-13	65	113

LOWER PART FOR MARINE DRAIN TYPE 470.000

WITH WELDING SLEEVE

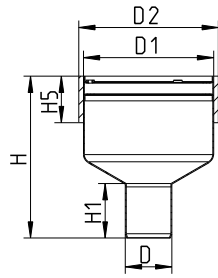

Type no.	EAN no.	EC/MED	D	D1	H	H1	H5	D2	Kg
470.000.050 S	5705499106145	A0-A60	50	140	174	58	50	150	1,73
470.000.075 S	5705499106169	A0-A60	75	140	172	63	50	150	1,60
470.000.110 S	5705499106183	A0-A60	110	140	146	75	50	150	1,70

LOWER PART FOR MARINE DRAIN TYPE 470.200

WITH WELDING FLANGE

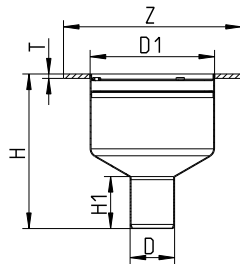

Type no.	EAN no.	EC/MED	D	D1	Z	H	H1	T	Kg
470.200.050 S	5705499106206	A0-A60	50	140	Ø200	174	58	5	1,30
470.200.075 S	5705499106220	A0-A60	75	140	Ø200	172	63	5	1,40
470.200.110 S	5705499106244	A0-A60	110	140	Ø200	141	75	5	1,24

LOWER PART FOR MARINE DRAIN TYPE 475.000

WITH WELDING SLEEVE

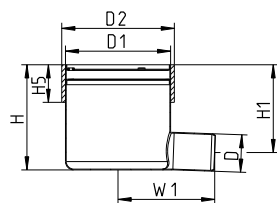

Type no.	EAN no.	EC/MED	D	D1	H	H1	H5	W1	D2	Kg
475.000.050 S	5705499106268	A0-A60	50	140	140	117	50	129	150	1,85
475.000.075 S	5705499106282	A0-A60	75	140	140	134	50	105	150	1,80

LOWER PART FOR MARINE DRAIN, HIGH MODEL TYPE 475.100

WITH WELDING SLEEVE

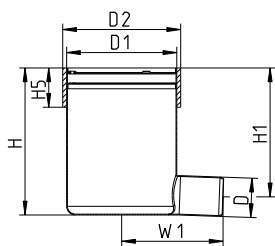

Type no.	EAN no.	EC/MED	D	D1	H	H1	H5	W1	D2	Kg
475.100.050 S	5705499106305	A0-A60	50	140	187	164	50	129	150	1,90

LOWER PART FOR MARINE DRAIN TYPE 475.200

WITH WELDING FLANGE

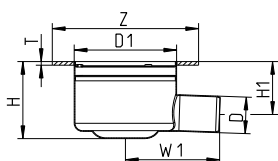

Type no.	EAN no.	EC/MED	D	D1	Z	H	H1	W1	T	Kg
475.200.050 S	5705499106329	A0-A60	50	140	Ø200	106	72	129	5	1,30
475.200.075 S	5705499106343	A0-A60	75	140	Ø200	106	71	134	5	1,35

Stainless steel drains and penetrations for aluminium structures



Welding directly into aluminium
Complete standard system
One system - one supplier

Applications

The products are suitable in particular for cruise liners, luxury yachts, ferries and other maritime vessels, where high strength combined with low weight is essential.

Details

Stainless steel drains and penetrations with a combined aluminium and stainless steel flange. This combination makes it possible to weld stainless steel directly into aluminium decks and bulkheads.

Please also see installation instruction 760878, or contact BLÜCHER for separate installation instructions.

Materials

Flange: Stainless steel and aluminium

Other: Stainless steel - AISI 316L

Tests

A salt mist test of the product range has been carried out at the Force Institute in Denmark.

All products are MED approved according to IMO Res. A. 754(18).

LOWER PART FOR MARINE DRAIN TYPE 480

WITH BIMETAL FLANGE

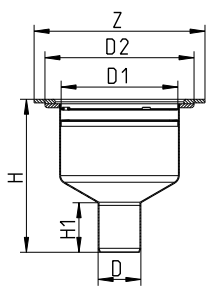

Type no.	EAN no.	EC/MED	D	D1	Z	H	H1	D2	Kg
480.200.050 S	5705499121841	A0-A60	50	140	Ø200	179	58	175	1,60
480.200.075 S	5705499121858	A0-A60	75	140	Ø200	177	63	175	1,50
480.200.110 S	5705499121889	A0-A60	110	140	Ø200	151	75	175	1,50

LOWER PART FOR MARINE DRAIN TYPE 485

WITH BIMETAL FLANGE

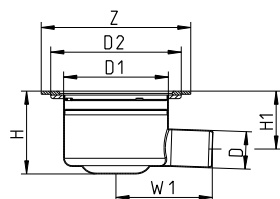

Type no.	EAN no.	EC/MED	D	D1	Z	H	H1	W1	D2	Kg
485.200.050 S	5705499121865	A0-A60	50	140	Ø200	111	78	128	175	1,50
485.200.075 S	5705499121872	A0-A60	75	140	Ø200	111	76	133	175	1,56

UPPER PART FOR MARINE DRAIN TYPE 471.300

WITH SIDE INLETS

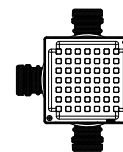
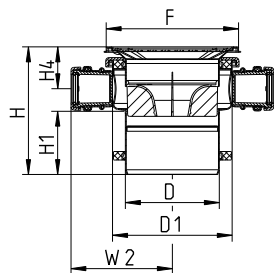

Type no.	EAN no.	D	D1	F	H	H1	H4	W2	Kg
471.300.110 S	5705499106367	110	140	155x155	150-160	74	49-59	119	3,00

UPPER PART FOR MARINE DRAIN TYPE 472.300

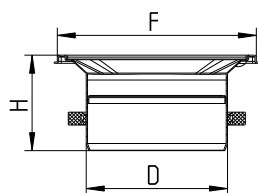

Type no.	EAN no.	D	F	H	Kg
472.300.110 S	5705499106381	110	155x155	74	0,70

UPPER PART FOR MARINE DRAIN TYPE 472.320

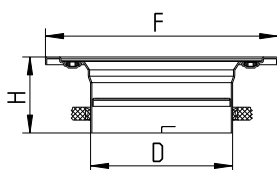

Type no.	EAN no.	D	F	H	Kg
472.320.110 S	5705499118537	110	Ø180	59	0,57

UPPER PART FOR MARINE DRAIN TYPE 473.300

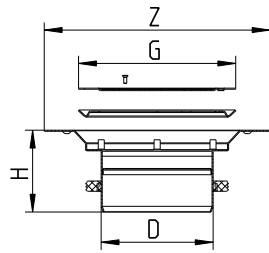

Type no.	EAN no.	D	Z	G	H	Kg
473.300.110 S	5705499106404	110	Ø222	Ø155	81	0,80

UPPER PART FOR MARINE DRAIN TYPE 473.301

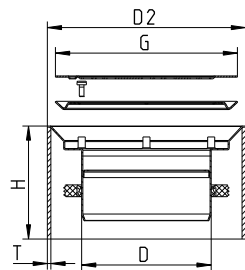

Type no.	EAN no.	D	G	H	D2	T	Kg
473.301.110 S	5705499107517	110	Ø155	96	168	3	0,80

GRATING SQUARE ATHENS

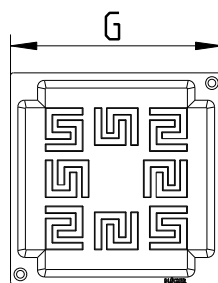

Type no.	EAN no.	G	T	Screws	Kg
610.155.427	5705499122848	140x140	2	2	0,26

GRATING SQUARE COPENHAGEN

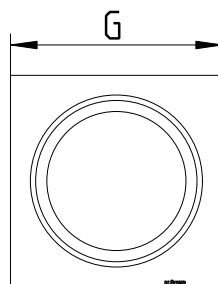
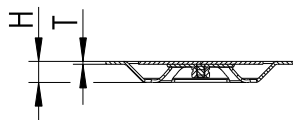

Type no.	EAN no.	G	H	T	Screws	Kg
610.155.521	5705499102192	140x140	16	2	0	0,44

GRATING SQUARE DETROIT

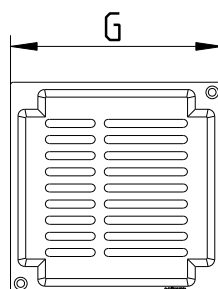

Type no.	EAN no.	G	T	Screws	Kg
610.155.428	5705499122916	140x140	2	2	0,25

GRATING SQUARE NEW YORK

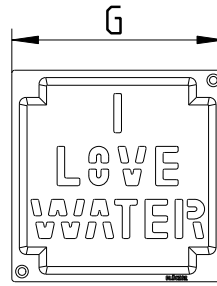
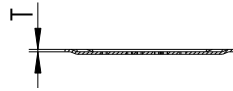

Type no.	EAN no.	G	T	Screws	Kg
610.155.429	5705499122985	140x140	2	2	0,27

GRATING SQUARE OSLO

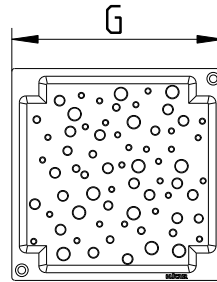
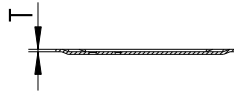
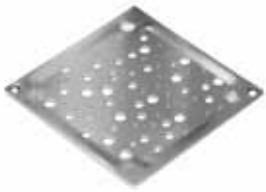

Type no.	EAN no.	G	T	Screws	Kg
610.155.426	5705499122770	140x140	2	2	0,29

GRATING SQUARE VIENNA

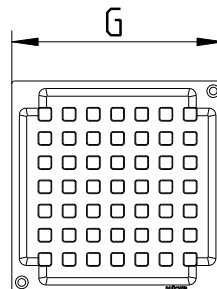

Type no.	EAN no.	G	T	Screws	Kg
610.155.421 S	5705499102130	140x140	2	2	0,33

GRATING CIRCLE VIENNA

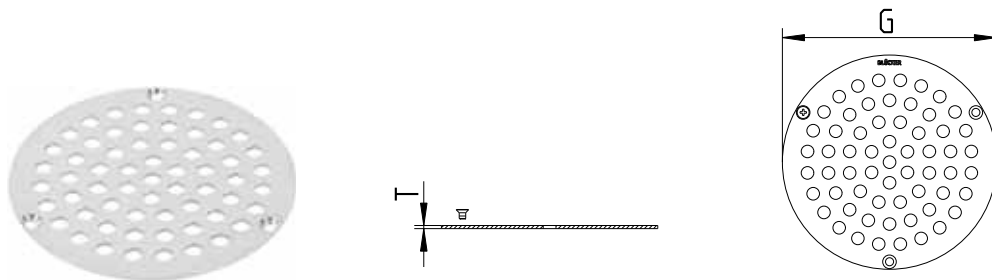

Type no.	EAN no.	G	T	Screws	Kg
620.135.021 S	5705499106466	Ø135	2	3	0,18

GRATING CIRCLE VIENNA

WITH SUPPORTING RING FOR WATER TRAP

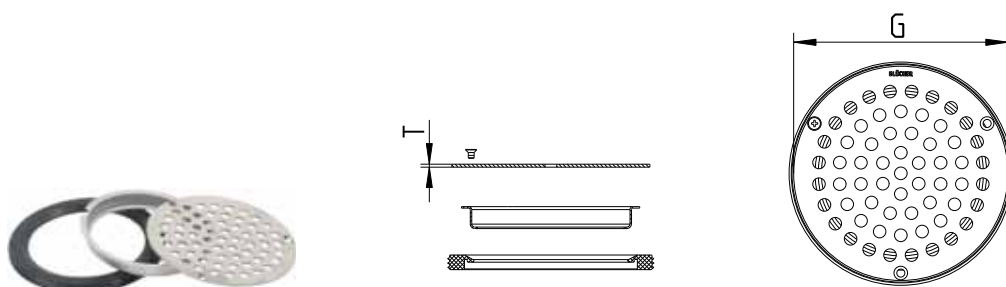

Type no.	EAN no.	G	T	Screws	Kg
474.300.110 S	5705499106428	Ø135	2	3	0,20

REMOVABLE WATER TRAP TYPE 502.052

WITH CR SEALING RING



Type no.	EAN no.	D	H	S	D2	Max Flow (l/s)	Kg
502.052.110 CRS	5705499114027	108	93	52	75	1.3	0,33

Accurate flow rate depending on type of drain and grating.

REMOVABLE MULTI WATER TRAP TYPE 503

WITH CR SEALING RING, PREVENTS SMELL

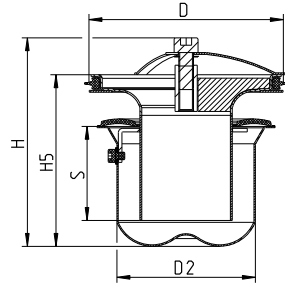

Type no.	EAN no.	D	H	H5	S	D2	Max Flow (l/s)	Kg
503.000.110 CR	5705499131918	108	113	93	51	75	1.2	0,39

Accurate flow rate depending on type of drain and grating.

P-TRAP 87,5° TYPE 525.090

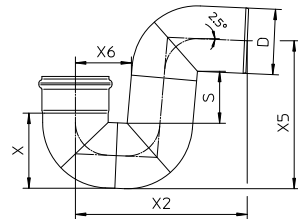

Type no.	EAN no.	D	S	X	X2	X5	X6	Max Flow (l/s)	Kg
525.090.050 S	5705499101461	50	74	63	175	145	60	1.7	0,45
525.090.075 S	5705499101478	75	81	89	222	189	74	2.5	0,84
525.090.110 S	5705499101485	110	89	126	289	249	94	3.4	1,49
525.090.125 S	5705499117974	125	110	154	330	292	102	4.4	1,88

Accurate flow rate depending on installation.

BOTTLE WATER TRAP TYPE 505

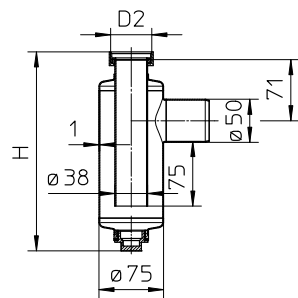

Type no.	EAN no.	H	D2	Kg
505.032.050 S	5705499101447	250	1¼	0,95
505.040.050 S	5705499101454	233	1½	0,85

75 mm water seal. D2 specified in inches ("). BSP thread.

EXTENSION PIPE TYPE 611

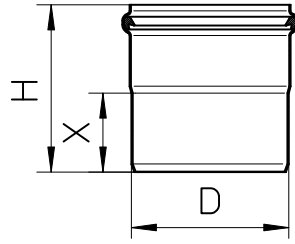

Type no.	EAN no.	D	H	X	Kg
611.300.001 S	5705499106442	110	117	55	0,40

Standard and customised channels for galleys, pantries and decks



Standard or customised solutions Hygienic design Gratings for any purpose and load class

Applications

For concrete, tiled, vinyl and epoxy flooring in:

- Industrial areas
- Commercial kitchens

Details

- Standard lengths 1 - 6 m (slot channels up to 12 m)
- Longitudinal and cross fall
- Four standard widths
- 2 mm material thickness
- 20 mm frame width
- Anchor tangs
- Gratings for weight loads from 250 to 12000 kg
- Combinable with BLÜCHER® Drain Marine accessories
- Stainless steel AISI304/EN 1.4301

Variants

- Outlet placed in end or center
- With or without outlet box
- With or without membrane flange

Options

- Removable water trap or P-trap
- Filter basket and sand bucket

Extras

- Reinforced frames for extra strong weight loads
- Stabiliser angle and adjustable legs
- Protective strip and grating lock device

Specialised in customised channels

Product database at www.blucher.com

Pipes and fittings for marine applications



Push-fit system
Light-weight
Fire tested

Applications

- Sanitary discharge, central vacuum cleaning or garbage disposal
- Cruise vessels, yachts, commercial vessels, navy vessels, offshore
- Completely interchangeable between vacuum and gravity systems

Details

- Standard dimensions from OD 50 up to OD 200mm
- Standard lengths from 0.15-6 metres
- 1-1,50 mm wall thickness
- EPDM lip sealing ring standard
- Complete range of fittings
- Complete range of approvals
- Stainless steel AISI 316L/EN1.4404

Variants

- Range of sealing rings
- Customised solutions available on request

Options

- Range of pipe hangers
- Easily combined with other pipe materials by means of adaptors
- Electrical or manual pipe cutters available for easy cutting on site

Complete system

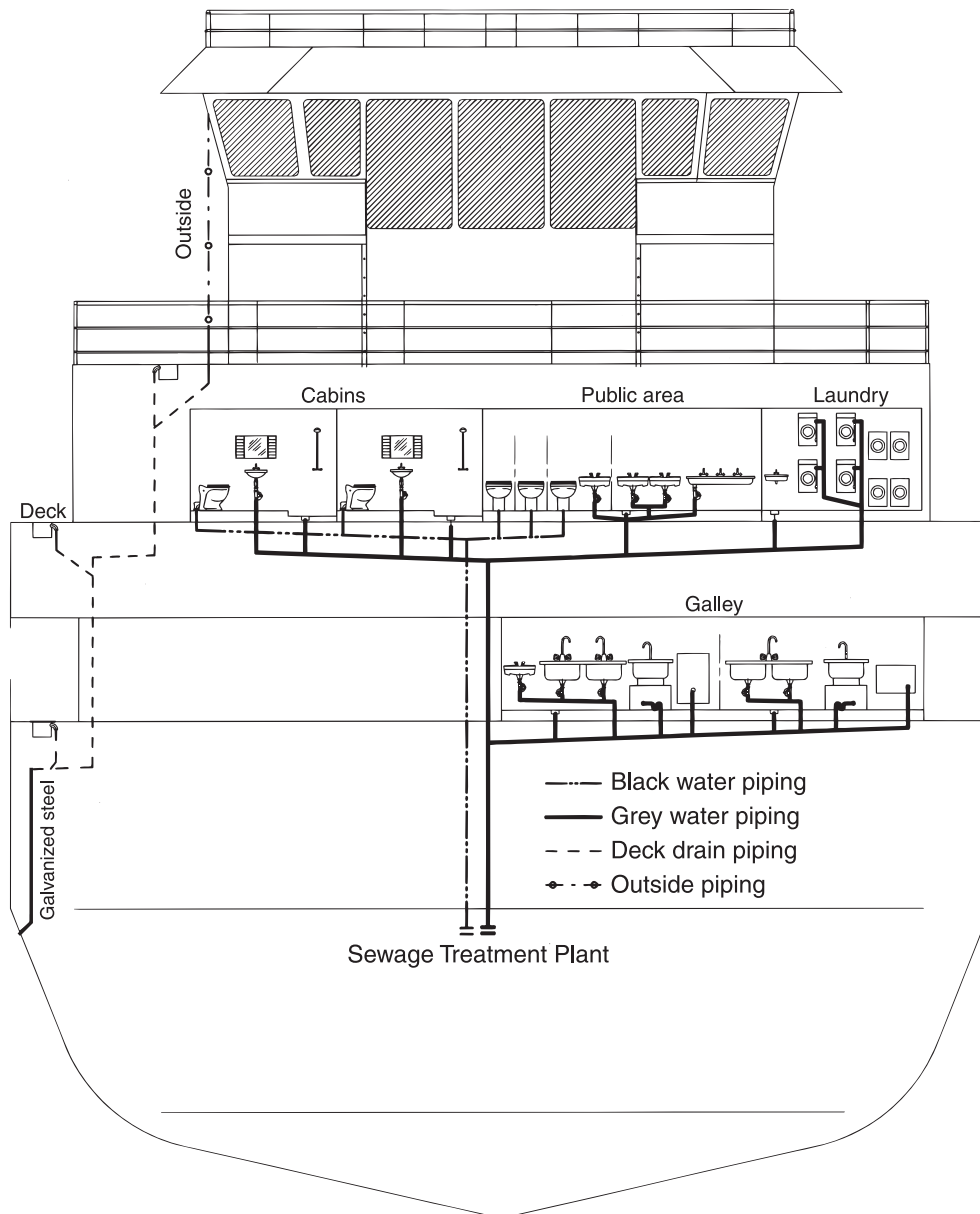

LEAKAGE TESTING

BLÜCHER recommends that the pipework system is tested for leakages before starting using the installation.

Gravity systems

Pipework installations to be tested at max. 0,5 bar, e.g. by blocking the installations on each deck and filling with water.

Vacuum systems

Pipework installations to be tested in accordance with the recommendations of the vacuum system supplier. BLÜCHER recommends max. -0,85 bar vacuum for OD 50 - 75 mm and max. -0,6 bar vacuum for pipe sizes bigger than OD 75 mm.

Applications

Gravity

OD 50 - 200 mm	+ 0,50 bar
With joint clamps:	
OD 50, 75, 110 mm	+ 2,00 bar
OD 125, 160 mm	+ 1,00 bar
With projections and joint clamps:	
OD 50, 75, 110, 125, 160 mm	+ 3,00 bar

Vacuum

OD 50 - 75 mm	- 0,85 bar
OD 110 - 160 mm	- 0,60 bar

Installation guide

Manual pipe cutter

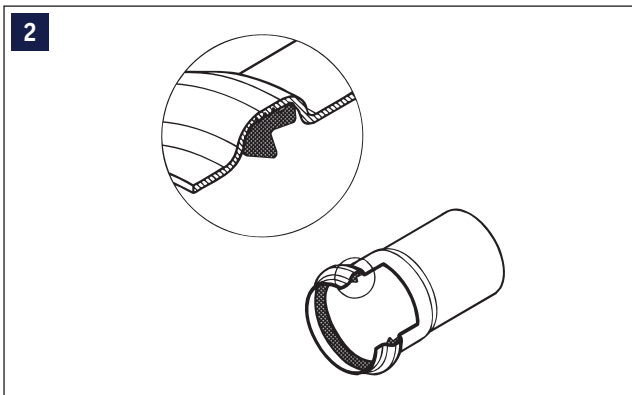
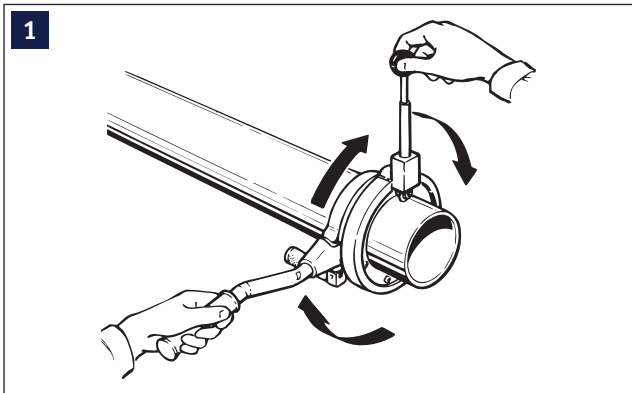

Joining of socket and spigot end

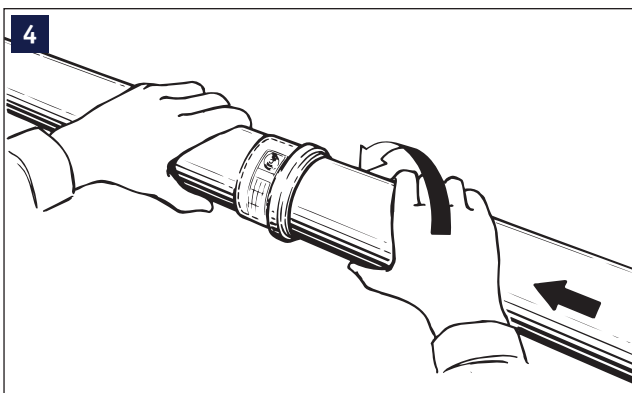
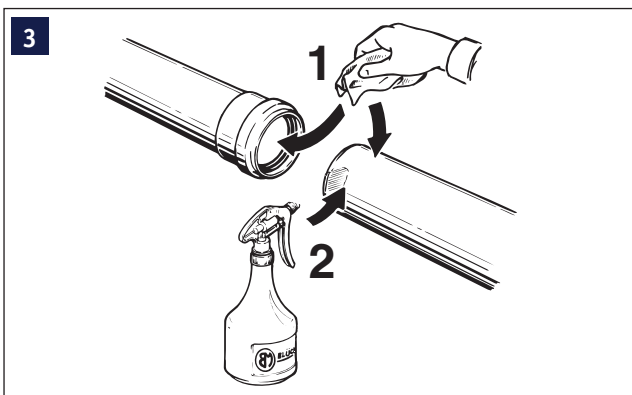

1. Cutting

Use BLÜCHER manual or electrical pipe cutter to cut the pipes. The pipes can then be installed without subsequent finishing.

N.B! Fittings may **not** be cut.

2. Check of lip seal

Check that the lip sealing ring is correctly installed in the socket.

3. Cleaning

If necessary, clean lip seal and socket before joining. Apply lubricant.

4. Joining

Joint the pipes with a slightly turning movement.

Electrical pipe cutter



A detailed user guide is provided when buying or lease an electrical pipe cutter

Insertion depth

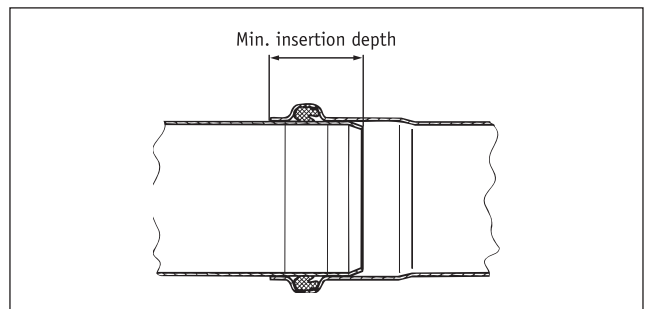

Pipe dimension in mm	Max. insertion depth from end of socket to spigot end	Min. insertion depth from end of socket to spigot end
OD 50 mm	47 mm	30 mm
OD 75 mm	55 mm	35 mm
OD110 mm	62 mm	40 mm
OD125 mm	65 mm	47 mm
OD160 mm	76 mm	50 mm
OD200 mm	98 mm	63 mm

Installation videos available at www.blucher.com

Suspension of drainage pipes

Vertical piping

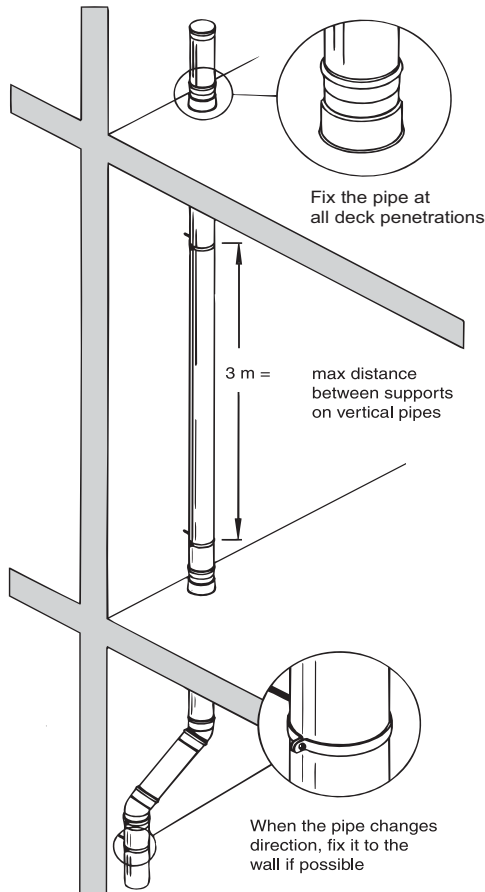

One fixing point per deck is normally sufficient. As opposed to plastic pipes, stainless steel pipes require only one pipe hanger per 3 metres, resulting in less sound and faster installation. Where larger inlets are connected, the downpipe must be secured immediately below the inlet.

Note: If other brackets are used, always use liner, i.e. rubber, between pipe and bracket.

The pipework system must be properly supported and fixed to prevent the socket and the spigot end from sliding apart under all anticipated conditions. If this is impossible (e.g. lack of space or fixing points) or extra security is required, clamps may also be used. Clamps must be used at each deck/bulkhead penetration.

BLÜCHER® EuroPipe joints are flexible up to 2° without this affecting the leakage tightness. This means that the pipework system will remain tight despite minor vibrations, while on the other hand the flexibility in the pipe joints make pipe installation easy.

Horizontal piping

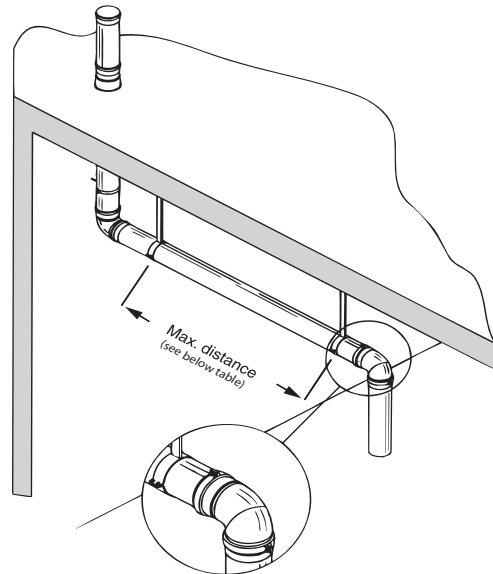

Horizontal pipe runs are always to be installed with a gradient. If no self-cleansing calculation is available, a gradient of 20 ‰ is recommended in gravity systems. Horizontal pipe runs in vacuum systems are to be installed in accordance with the recommendations of the vacuum system supplier.

Dim.	Distance between supports*
mm	m ¹⁾
50	2,2
75	2,5
110	2,8
125	3,0
160	3,3
200	3,3

* The distance between the suspended fixing points must be calculated on the basis of a permissible 1 mm bending of the pipe. The deflection for a single mounting is calculated for a water-filled pipe.

1) Applies to flat lengths of pipe. Where there are fittings in the suspended piping, the mounting points must be so placed that either the branch or the through pipe is held directly behind the sleeve. If this is not possible, the span must be reduced to half the quoted values or, as an alternative, safety clamps may be installed for stability.

Longitudinal expansion

The figure below shows the relationship between pipe length L in m and longitudinal expansion Δl in mm for various temperature differences Δt.

Example: A 3 m pipe will expand by 2,5 mm at a temperature difference of 50°C.

The increase in length for a given pipe length can also be calculated from the following formula.

$$\Delta l = 0,0165 \times \Delta t \times L$$

where

Δl = longitudinal expansion in mm

0,0165 = coefficient of expansion in mm/m/°C

Δt = temperature difference in °C

(Δt = max. temp. in the pipe system

- temperature when pipe system installed)

L = length of the pipe system in m.

The longitudinal expansion can usually be absorbed in the socket joint.

Longitudinal expansion diagram

The below graphs demonstrate the relationship between pipe length (l) and longitudinal expansion Δl) at various temperature differences (Δt).

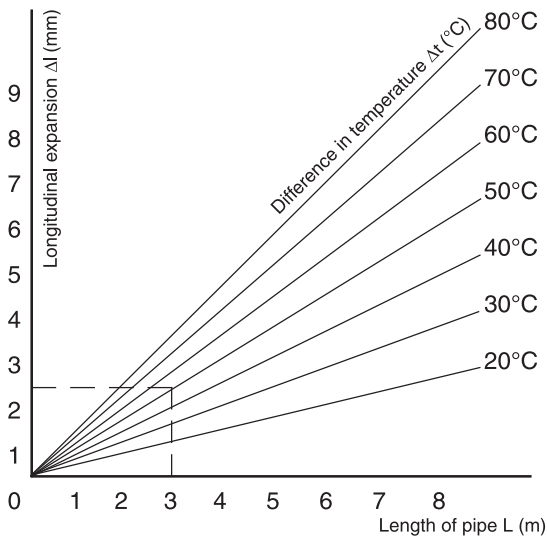

Example: A pipe of 3 m expands longitudinally by approx. 2,5 mm at a temperature difference of 50° C.

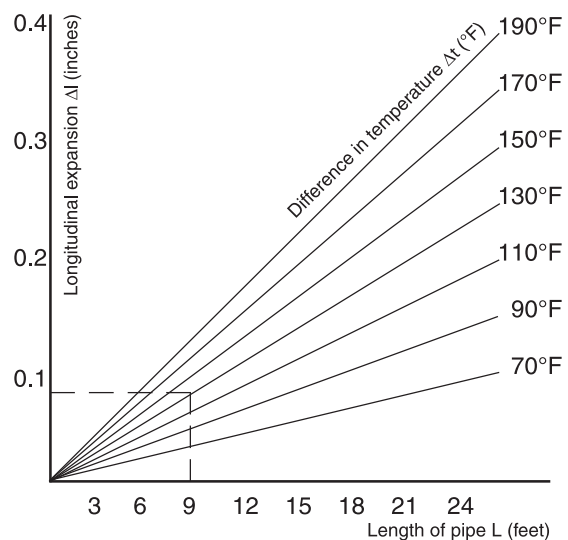

Example: A pipe of 9 ft. expands longitudinally by approx. 0,097 ins. at a temperature difference of 130° F.

DIMENSIONAL DRAWING, SOCKET AND SPIGOT END

PIPES AND FITTINGS

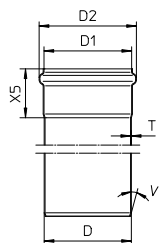

Type no.	EAN no.	D	D1	D2	X5	T	V
811.XXX.040		40	41	52	46	1	20
811.XXX.050		50	51	61	47	1	20
811.XXX.075		75	76	87	55	1	20
811.XXX.110		110	111	123	62	1	20
811.XXX.125		125	126	140	65	1	20
811.XXX.160		160	161	177	78	1.25	20
811.XXX.200		200	201	219	98	1.5	20

STRAIGHT PIPE WITH ONE SOCKET TYPE 811

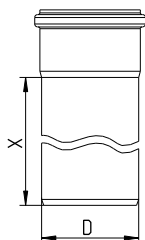

Type no.	EAN no.	D	X	Kg
811.015.040 S	5705499412642	40	150	0,20
811.025.040 S	5705499412666	40	250	0,29
811.050.040 S	5705499412680	40	500	0,00
811.075.040 S	5705499412703	40	750	0,78
811.100.040 S	5705499412727	40	1000	1,02
811.150.040 S	5705499412741	40	1500	1,50
811.200.040 S	5705499412765	40	2000	1,99
811.300.040 S	5705499412789	40	3000	2,96
811.400.040 S	5705499412802	40	4000	3,92
811.500.040 S	5705499412826	40	5000	4,89
811.600.040 S	5705499412840	40	6000	5,86

811.015.050 S	5705499400212	50	150	0,25
811.025.050 S	5705499400298	50	250	0,38
811.050.050 S	5705499400373	50	500	0,68
811.075.050 S	5705499400458	50	750	1,00
811.100.050 S	5705499400533	50	1000	1,25
811.150.050 S	5705499400618	50	1500	1,90
811.200.050 S	5705499400694	50	2000	2,45
811.300.050 S	5705499400786	50	3000	3,82
811.400.050 S	5705499400861	50	4000	5,06
811.500.050 S	5705499400946	50	5000	6,31
811.600.050 S	5705499401028	50	6000	7,56

811.015.075 S	5705499400236	75	150	0,41
811.025.075 S	5705499400311	75	250	0,58
811.050.075 S	5705499400397	75	500	1,00
811.075.075 S	5705499400472	75	750	1,50
811.100.075 S	5705499400557	75	1000	1,95
811.150.075 S	5705499400632	75	1500	2,75
811.200.075 S	5705499400717	75	2000	3,70
811.300.075 S	5705499400809	75	3000	5,78
811.400.075 S	5705499400885	75	4000	7,66
811.500.075 S	5705499400960	75	5000	9,54
811.600.075 S	5705499401042	75	6000	11,42

811.015.110 S	5705499400250	110	150	0,61
811.025.110 S	5705499400335	110	250	0,87
811.050.110 S	5705499400410	110	500	1,50
811.075.110 S	5705499400496	110	750	2,15
811.100.110 S	5705499400571	110	1000	2,85
811.150.110 S	5705499400656	110	1500	4,30
811.200.110 S	5705499400731	110	2000	5,40
811.300.110 S	5705499400823	110	3000	8,50
811.400.110 S	5705499400908	110	4000	11,26
811.500.110 S	5705499400984	110	5000	14,00
811.600.110 S	5705499401066	110	6000	16,78

811.015.125 S	5705499410846	125	150	0,70
811.025.125 S	5705499408225	125	250	1,01
811.050.125 S	5705499408249	125	500	1,78
811.075.125 S	5705499408256	125	750	2,55
811.100.125 S	5705499408270	125	1000	3,32
811.150.125 S	5705499408294	125	1500	4,86
811.200.125 S	5705499408317	125	2000	6,40
811.300.125 S	5705499408324	125	3000	9,47
811.400.125 S	5705499410921	125	4000	12,55

Continues on next page

All dimensions in mm - If Stainless Steel grade AISI 304 / EN 1.4301 is required specify type no. without suffix S

STRAIGHT PIPE WITH ONE SOCKET TYPE 811

Type no.	EAN no.	D	X	Kg
Continued from previous page				
811.500.125 S	5705499410945	125	5000	15,63
811.600.125 S	5705499410969	125	6000	18,71
-----		-----	-----	-----
811.015.160 S	5705499400274	160	150	1,19
811.025.160 S	5705499400359	160	250	1,69
811.050.160 S	5705499400434	160	500	2,96
811.075.160 S	5705499400519	160	750	4,22
811.100.160 S	5705499400595	160	1000	5,48
811.150.160 S	5705499400670	160	1500	8,02
811.200.160 S	5705499400755	160	2000	10,54
811.300.160 S	5705499400847	160	3000	15,59
811.400.160 S	5705499400922	160	4000	20,64
811.500.160 S	5705499401004	160	5000	25,69
811.600.160 S	5705499401080	160	6000	30,74
-----		-----	-----	-----
811.015.200 S	5705499411522	200	150	1,96
811.025.200 S	5705499411539	200	250	2,77
811.050.200 S	5705499410853	200	500	4,62
811.075.200 S	5705499411546	200	750	6,47
811.100.200 S	5705499410877	200	1000	8,32
811.200.200 S	5705499410884	200	2000	15,71
811.300.200 S	5705499410891	200	3000	23,10

- Bends

BEND 15° TYPE 820.015

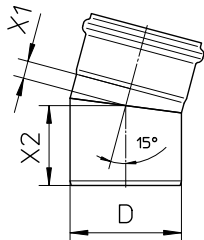

Type no.	EAN no.	D	X1	X2	Kg
820.015.040 S	5705499412864	40	11	53	0,12
820.015.050 S	5705499401134	50	14	54	0,15
820.015.075 S	5705499401158	75	16	66	0,28
820.015.110 S	5705499401172	110	20	78	0,47
820.015.125 S	5705499408614	125	14	84	0,56
820.015.160 S	5705499401196	160	23	99	1,08
820.015.200 S	5705499410976	200	23	123	1,99

BEND 30° TYPE 820.030

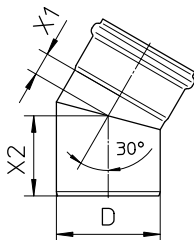

Type no.	EAN no.	D	X1	X2	Kg
820.030.040 S	5705499412888	40	14	55	0,13
820.030.050 S	5705499401233	50	18	57	0,16
820.030.075 S	5705499401257	75	20	71	0,28
820.030.110 S	5705499401271	110	28	85	0,51
820.030.125 S	5705499408669	125	23	98	0,63
820.030.160 S	5705499401295	160	34	110	1,15
820.030.200 S	5705499410983	200	37	137	2,20

BEND 45° TYPE 820.045

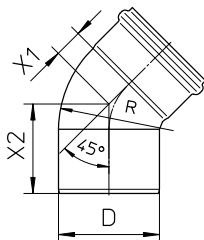

Type no.	EAN no.	D	X1	X2	R	Kg
820.045.040 S	5705499412901	40	17	58	40	0,13
820.045.050 S	5705499401318	50	21	60	50	0,17
820.045.075 S	5705499401332	75	28	76	75	0,30
820.045.110 S	5705499401356	110	38	93	110	0,56
820.045.125 S	5705499408683	125	53	111	125	0,73
820.045.160 S	5705499401370	160	49	131	172	1,55

BEND, LARGE RADIUS 45° TYPE 820.045

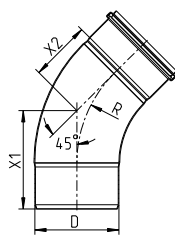

Type no.	EAN no.	D	X1	X2	R	Kg
820.045.200 S	5705499410990	200	136	234	400	4,18
820.045.250 S	5705499121612	250	176	280	500	6,53

BEND 87.5° TYPE 820.090

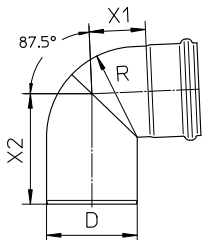

Type no.	EAN no.	D	X1	X2	R	Kg
820.090.040 S	5705499412925	40	28	79	40	0,16
820.090.050 S	5705499401394	50	35	86	50	0,21
820.090.075 S	5705499401417	75	48	107	75	0,39
820.090.110 S	5705499401431	110	68	134	110	0,67
820.090.125 S	5705499408737	125	88	161	125	1,68
820.090.160 S	5705499401455	160	99	181	171	2,10

To comply with BS EN 12056 Gravity Drainage inside Buildings use 821 bend at offsets and base of stack.

- Bends

BEND, LARGE RADIUS 87.5° TYPE 820.090

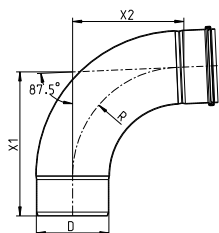

Type no.	EAN no.	D	X1	X2	R	Kg
820.090.200 S	5705499411423	200	299	397	400	6,41
820.090.250 S	5705499121629	250	380	484	500	9,88

To comply with BS EN 12056 Gravity Drainage inside Buildings use 821 bend at offsets and base of stack.

BEND, LONG RADIUS 87.5°, 50 MM TYPE 821.000

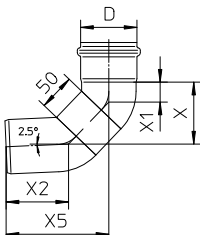

Type no.	EAN no.	D	X	X1	X2	X5	Kg
821.000.050 S	5705499404012	50	72	22	72	120	0,30
821.000.075 S	5705499404036	75	85	27	86	141	0,50

- Branches

BRANCH 87.5° TYPE 830

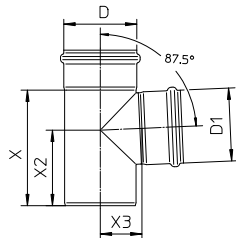

Type no.	EAN no.	D	D1	X	X2	X3	Kg
830.040.040 S	5705499412949	40	40	97	69	24	0,22
830.040.050 S	5705499412963	50	40	102	71	31	0,26
830.050.050 S	5705499401615	50	50	101	71	31	0,27
830.050.075 S	5705499401639	75	50	134	98	44	0,44
830.050.110 S	5705499401653	110	50	127	93	61	0,64
830.075.075 S	5705499401691	75	75	134	90	47	0,50
830.075.110 S	5705499401714	110	75	147	104	65	0,76
830.075.125 S	5705499408959	125	75	182	110	72	0,94
830.110.110 S	5705499401738	110	110	178	117	64	0,88
830.110.125 S	5705499408980	125	110	200	127	71	1,25
830.110.160 S	5705499401752	160	110	230	152	88	1,83
830.125.125 S	5705499409017	125	125	215	135	77	1,17
830.160.160 S	5705499401776	160	160	282	184	98	2,40
830.160.200 S	5705499411003	200	160	285	186	116	3,45
830.200.200 S	5705499411010	200	200	325	206	120	4,17

To comply with BS EN 12056 Gravity Drainage inside Buildings, when using non reducing branch consider branch type 838, 848 or 839

DOUBLE BRANCH 87.5° TYPE 831

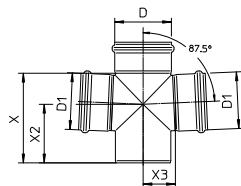

Type no.	EAN no.	D	D1	X	X2	X3	Kg
831.050.050 S	5705499401790	50	50	101	71	31	0,36
831.050.075 S	5705499401813	75	50	134	98	44	0,54
831.050.110 S	5705499401837	110	50	127	93	61	0,72
831.075.075 S	5705499401851	75	75	134	90	47	0,66
831.075.110 S	5705499401875	110	75	147	104	64	0,89
831.110.110 S	5705499401899	110	110	178	117	64	1,13
831.110.160 S	5705499401912	160	110	230	152	88	2,05
831.160.160 S	5705499401936	160	160	282	184	98	2,91

To comply with BS EN 12056 Gravity Drainage inside Buildings, when using non reducing branch consider branch type 836.

DOUBLE BRANCH 87.5° TYPE 832

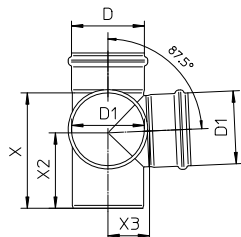

Type no.	EAN no.	D	D1	X	X2	X3	Kg
832.050.050 S	5705499401950	50	50	101	71	31	0,36
832.050.075 S	5705499401974	75	50	134	98	44	0,54
832.050.110 S	5705499401998	110	50	127	93	61	0,72
832.075.075 S	5705499402018	75	75	134	90	47	0,66
832.075.110 S	5705499402032	110	75	147	104	64	0,89
832.110.110 S	5705499402056	110	110	178	117	64	1,13
832.110.160 S	5705499402070	160	110	230	152	88	2,07
832.160.160 S	5705499402094	160	160	282	184	98	2,91

To comply with BS EN 12056 Gravity Drainage inside Buildings, when using non reducing branch consider branch type 837.

DOUBLE BRANCH 45° TYPE 836

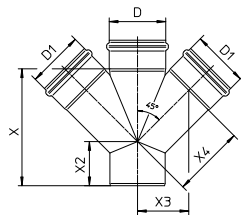

Type no.	EAN no.	D	D1	X	X2	X3	X4	Kg
836.050.050 S	5705499402117	50	50	123	57	50	71	0,59
836.050.075 S	5705499402131	75	50	139	56	63	89	0,69
836.050.110 S	5705499402155	110	50	142	42	81	114	0,80
836.075.075 S	5705499402179	75	75	174	74	74	105	1,15
836.075.110 S	5705499402193	110	75	178	60	92	130	1,31
836.110.110 S	5705499402216	110	110	228	88	102	144	2,10
836.110.160 S	5705499402223	160	110	252	80	128	180	2,85
836.160.160 S	5705499402230	160	160	322	115	151	216	5,28

- Branches

DOUBLE BRANCH 45° TYPE 837

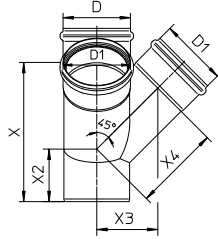

Type no.	EAN no.	D	D1	X	X2	X3	X4	Kg
837.050.050 S	5705499402254	50	50	123	57	50	71	0,49
837.050.075 S	5705499402278	75	50	139	56	63	89	0,67
837.050.110 S	5705499402285	110	50	142	42	81	114	0,92
837.075.075 S	5705499402292	75	75	174	74	74	105	1,43
837.075.110 S	5705499402308	110	75	177	60	92	130	1,31
837.110.110 S	5705499402322	110	110	228	88	102	144	2,07
837.110.160 S	5705499402339	160	110	252	80	128	180	2,07
837.160.160 S	5705499402346	160	160	322	115	151	216	4,02

OBLIQUE BRANCH 45° TYPE 838

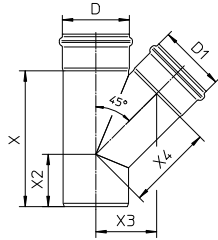

Type no.	EAN no.	D	D1	X	X2	X3	X4	Kg
838.040.040 S	5705499413007	40	40	114	58	42	59	0,25
838.040.050 S	5705499413021	50	40	157	55	47	67	0,30
838.050.050 S	5705499402360	50	50	123	57	50	71	0,32
838.050.075 S	5705499402384	75	50	139	56	63	89	0,48
838.050.110 S	5705499402407	110	50	142	42	81	114	0,70
838.075.075 S	5705499402421	75	75	174	74	74	105	0,64
838.075.110 S	5705499402445	110	75	177	60	92	130	0,88
838.075.125 S	5705499409321	125	75	195	65	96	136	1,32
838.110.110 S	5705499402469	110	110	228	88	102	144	1,16
838.110.125 S	5705499409345	125	110	245	90	106	149	1,50
838.110.160 S	5705499402483	160	110	252	80	128	180	2,11
838.125.125 S	5705499409369	125	125	268	103	117	165	1,49
838.160.160 S	5705499402506	160	160	322	115	151	216	3,04
838.160.200 S	5705499411027	200	160	351	123	172	242	4,37
838.200.200 S	5705499411034	200	200	407	151	189	266	5,47

SWEPT BRANCH 87.5° TYPE 839

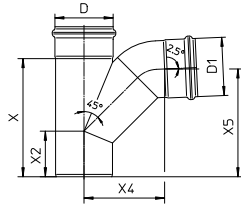

Type no.	EAN no.	D	D1	X	X2	X4	X5	Kg
839.050.050 S	5705499402520	50	50	123	57	80	121	0,44
839.050.075 S	5705499402544	75	50	139	56	92	128	0,60
839.050.110 S	5705499402568	110	50	142	42	110	132	0,81
839.075.075 S	5705499402582	75	75	174	74	108	160	0,87
839.075.110 S	5705499402605	110	75	177	60	125	160	1,11
839.110.110 S	5705499402629	110	110	228	88	155	211	1,64
839.110.160 S	5705499402643	160	110	252	80	180	227	2,53
839.160.160 S	5705499402667	160	160	322	115	219	298	4,52

- Sockets

DOUBLE COUPLING TYPE 841

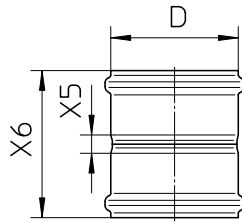

Type no.	EAN no.	D	X5	X6	Kg
841.040.040 S	5705499413045	40	20	104	0,13
841.050.050 S	5705499402742	50	13	97	0,15
841.075.075 S	5705499402766	75	20	120	0,26
841.110.110 S	5705499402780	110	16	130	0,45
841.125.125 S	5705499409482	125	20	140	0,54
841.160.160 S	5705499402803	160	20	162	1,05
841.200.200 S	5705499411065	200	20	200	1,85

DOUBLE SLIP COUPLING TYPE 842

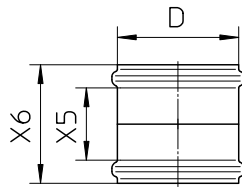

Type no.	EAN no.	D	X5	X6	Kg
842.040.040 S	5705499413069	40	76	104	0,13
842.050.050 S	5705499402810	50	71	97	0,12
842.075.075 S	5705499402827	75	91	120	0,21
842.110.110 S	5705499402834	110	97	130	0,45
842.125.125 S	5705499409550	125	104	140	0,47
842.160.160 S	5705499402841	160	118	162	1,05
842.200.200 S	5705499411072	200	147	200	1,82

EXPANSION SOCKET TYPE 843

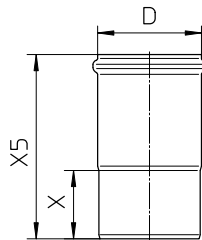

Type no.	EAN no.	D	X	X5	Kg
843.095.040 S	5705499413083	40	51	150	0,17
843.105.050 S	5705499402865	50	52	159	0,21
843.115.075 S	5705499402889	75	57	175	0,36
843.125.110 S	5705499402902	110	74	200	0,57
843.140.125 S	5705499122510	125	94	240	0,81
843.182.160 S	5705499402926	160	116	292	1,55

EXPANSION SOCKET, LONG MODEL TYPE 869

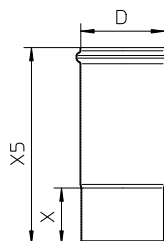

Type no.	EAN no.	D	X	X5	Kg
869.143.050 S	5705499410624	50	52	200	0,25
869.163.075 S	5705499410648	75	57	225	0,40
869.181.110 S	5705499410662	110	74	260	0,70
869.200.125 S	5705499412208	125	94	300	0,99
869.238.160 S	5705499410686	160	116	360	1,85
869.300.200 S	5705499121353	200	112	420	2,43

- Increasers and reducers

INCREASER ECCENTRIC TYPE 850

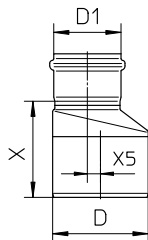

Type no.	EAN no.	D	D1	X	X5	Kg
850.050.075 S	5705499403091	75	50	82	7	0,22
850.050.110 S	5705499403114	110	50	108	25	0,38
850.075.110 S	5705499403152	110	75	111	15	0,42
850.075.160 S	5705499403176	160	75	172	37	1,20
850.110.160 S	5705499403213	160	110	135	22	1,06

INCREASER CONCENTRIC TYPE 850

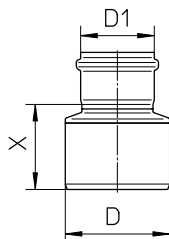

Type no.	EAN no.	D	D1
850.040.050 CS	5705499132458	50	40
850.040.075 CS	5705499132472	75	40
850.050.075 CS	5705499409734	75	50
850.050.110 CS	5705499408454	110	50
850.075.110 CS	5705499409741	110	75
850.110.125 CS		125	110
850.110.160 CS	5705499408461	160	110
850.125.200 CS	5705499132649	200	125
850.125.160 CS		160	125
850.160.200 CS	5705499132687	200	160
850.160.250 CS	5705499132700	250	160
850.200.250 CS	5705499132724	250	200

- Adaptors

DIN FLANGE ADAPTOR TYPE 854.X00

WITH SOCKET AND FLANGE PN16 DIN 2633/EN1092-1

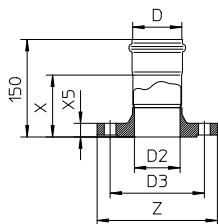

Type no.	EAN no.	D	Z.	D2	D3	X	X5	Kg
854.200.040 S	5705499413205	40	150	43	110	104	18	2,21
854.200.050 S	5705499403831	50	150	43	110	103	19	2,10
854.200.075 S	5705499403848	75	185	70	145	95	21	3,40
854.300.040 S	5705499413212	40	165	55	125	104	18	2,62
854.300.050 S	5705499403879	50	165	51	125	103	21	2,80
854.300.110 S	5705499403886	110	220	107	180	88	23	5,00

DIN FLANGE ADAPTOR TYPE 854.X10

WITH SPIGOT AND FLANGE PN16 DIN 2633/EN1092-1

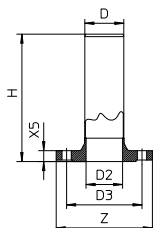

Type no.	EAN no.	D	Z.	H.	D2	D3	X5	Kg
854.210.040 S	5705499413229	40	150	150	43	110	18	2,19
854.210.050 S	5705499403855	50	150	234	43	110	19	2,10
854.210.075 S	5705499403862	75	185	245	70	145	21	3,45
854.310.040 S	5705499413236	40	165	150	55	125	18	2,60
854.310.050 S	5705499403893	50	165	192	51	125	21	2,80
854.310.110 S	5705499403909	110	220	259	107	180	23	5,15

ANSI FLANGE ADAPTOR TYPE 854.025

WITH SOCKET AND FLANGE ANSI B16.5

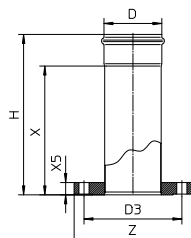

Type no.	EAN no.	D	Z.	H.	D3	X	X5	Kg
854.025.040 S	5705499413243	40	152	292	121	250	19	2,56
854.025.050 S	5705499409871	50	152	297	121	250	20	2,52
854.025.075 S	5705499409888	75	191	305	153	250	24	4,72
854.025.110 S	5705499409895	110	229	312	191	250	24	6,14
854.025.160 S	5705499409901	160	279	328	242	250	24	6,50

ANSI FLANGE ADAPTOR TYPE 854.035

WITH SPIGOT AND FLANGE ANSI B16.5

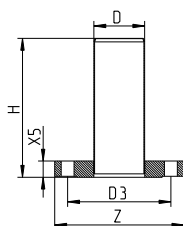

Type no.	EAN no.	D	Z.	H.	D3	X5	Kg
854.035.040 S	5705499413250	40	152	200	121	19	2,56
854.035.050 S	5705499127591	50	152	197	121	19	2,39
854.035.075 S	5705499127607	75	191	205	152	24	4,52
854.035.110 S	5705499127614	110	229	212	191	24	5,85

- Adaptors

FEMALE ADAPTOR TYPE 885

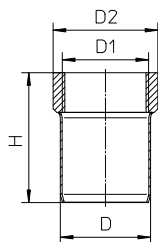

Type no.	EAN no.	D	D1	H.	D2	Kg
885.025.050 S	5705499403435	50	1	93	40	0,18
885.032.050 S	5705499403459	50	1¼	72	48	0,17
885.040.050 S	5705499403466	50	1½	72	58	0,19
885.050.050 S	5705499403473	50	2	77	67	0,22

D1 specified in inches ("). BSP thread.

MALE ADAPTOR TYPE 886

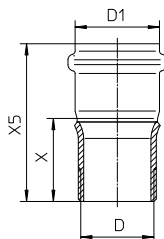

Type no.	EAN no.	D	D1	X	X5	Kg
886.050.032 S	5705499403480	1¼	50	97	50	0,25
886.050.040 S	5705499403497	1½	50	98	52	0,23
886.050.050 S	5705499403503	2	50	98	52	0,27

D specified in inches ("). BSP thread.

- Toilet adaptors

TOILET ADAPTOR STRAIGHT TYPE 855.090

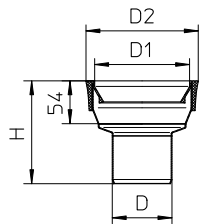

Type no.	EAN no.	D	D1	H.	D2	Kg
855.090.075 S	5705499403299	75	110	129	141	0,42
855.090.110 S	5705499403305	110	110	124	141	0,39

- Others

TRANSPORT POCKET TYPE 873

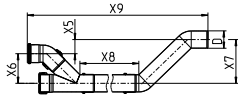

Type no.	EAN no.	D	X5	X6	X7	X8	X9	Kg
873.000.050 S	5705499131727	50	61	93	154	809	1224	2,16
873.000.075 S	5705499131734	75	61	128	188	819	1344	4,63

GOOSE NECK TYPE 874

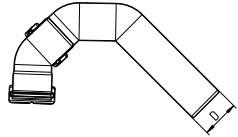

Type no.	EAN no.	D	Kg
874.000.050 S	5705499131703	50	0,78
874.000.075 S	5705499131710	75	1,38

Clamps

PIPE JOINT CLAMP TYPE 847

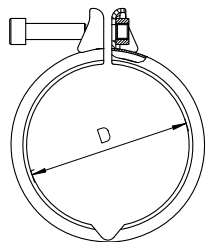

Type no.	EAN no.	D
847.050.050	5705499412420	50
847.075.075	5705499412437	75
847.110.110	5705499412444	110
847.125.125	5705499412451	125
847.160.160	5705499412468	160
847.200.200	5705499412475	200

Clamps are recommended to be used at each deck/bulkhead penetration and drain for marine installations.

Pipe hangers

PIPE HANGER WITH EPDM RUBBER TYPE 895.012

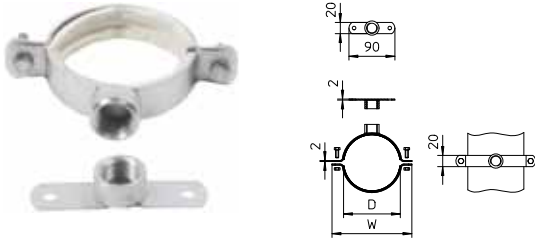

Type no.	EAN no.	D	W
895.012.040 GS	5705499413113	40	90
895.012.050 GS	5705499403558	50	101
895.012.075 GS	5705499403565	75	126
895.012.110 GS	5705499403572	110	161
895.012.160 GS	5705499403589	160	211

With 1/2" BSP thread.

PIPE HANGER WITH EPDM RUBBER TYPE 895.200

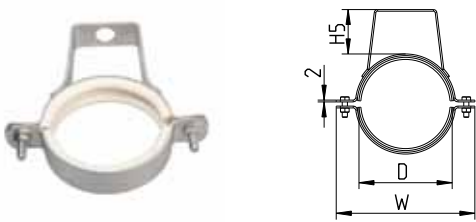

Type no.	EAN no.	D	H5	W
895.200.040 S	5705499413120	40	38	90
895.200.050 S	5705499410747	50	38	101
895.200.075 S	5705499410754	75	54	126
895.200.110 S	5705499410761	110	52	161
895.200.160 S	5705499410778	160	71	211

PIPE HANGER WITH EPDM RUBBER TYPE 895.300



Type no.	EAN no.	D	W
895.300.040 GS	5705499413137	40	90
895.300.050 GS	5705499403633	50	101
895.300.075 GS	5705499403640	75	126
895.300.110 GS	5705499403657	110	161
895.300.160 GS	5705499403664	160	211

PIPE HANGER WITH SI RUBBER TYPE 895.403



Type no.	EAN no.	D	H	W	X5	T
895.403.040 S	5705499413168	40				
895.403.050 S	5705499128161	50	20	97	41	2
895.403.075 S	5705499128178	75	20	118	52	2
895.403.110 S	5705499128185	110	20	158	78	2.5
895.403.125 S	5705499128192	125	20	170	84	2.5
895.403.160 S	5705499128208	160	25	233	108	2.5
895.403.200 S	5705499128215	200	25	273	123	3

D=75mm fits D=82mm as well.

Plugs

SOCKET PLUG TYPE 844.000

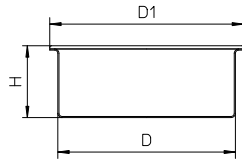

Type no.	EAN no.	D	D1	H.
844.000.040 S	5705499413175	40	50	32
844.000.050 S	5705499402933	50	58	50
844.000.075 S	5705499402940	75	85	45
844.000.110 S	5705499402957	110	120	45
844.000.125 S	5705499412222	125	135	43
844.000.160 S	5705499402964	160	170	45
844.000.200 S	5705499412239	200	210	50

Use of pipe joint clamp type 847 is necessary if any pressure in the pipe system is expected.

SOCKET PLUG TYPE 844.100

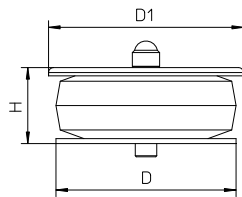

Type no.	EAN no.	D	D1	H.
844.100.050 S	5705499411393	50	59	31
844.100.075 S	5705499411409	75	83	36
844.100.110 S	5705499411416	110	118	36
845.000.160 S	5705499403008	160	170	45

Use of pipe joint clamp type 847 is recommended if the pressure in the pipe system is expected to exceed 0.5 bar for D<110mm and 0.3 bar for D=110mm.

Sealing rings

EPDM LIP SEALING RING BLACK TYPE 801

FOR STANDARD USE

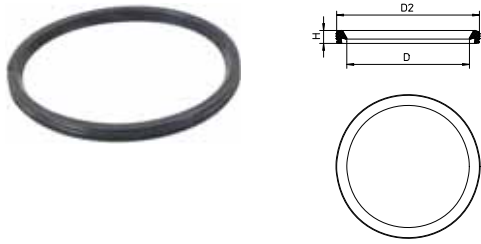

Type no.	EAN no.	D	H	D2
801.EPDM.040	5705499403930	40	7.8	51.7
801.EPDM.050	5705499400038	50	7.8	61.8
801.EPDM.075	5705499400045	75	7.8	87.1
801.EPDM.110	5705499400069	110	8.9	124.2
801.EPDM.125	5705499408096	125	10.2	142.3
801.EPDM.160	5705499400076	160	11.5	180.1
801.EPDM.200	5705499410785	200	12.8	223.8

FPM LIP SEALING RING PURPLE TYPE 801

FOR HIGH TEMPERATURES

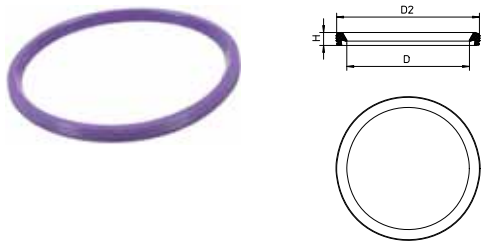

Type no.	EAN no.	D	H	D2
801.FPM.040		40		
801.FPM.050	5705499408102	50	7.8	61.8
801.FPM.075	5705499408119	75	7.8	87.1
801.FPM.110	5705499408126	110	8.9	124.2
801.FPM.125	5705499410792	125	10.2	142.3
801.FPM.160	5705499408133	160	11.5	180.1
801.FPM.200	5705499410808	200	12.8	223.8

NBR LIP SEALING RING BLACK/YELLOW TYPE 801

FOR USE WITH OIL



Type no.	EAN no.	D	H	D2
801.NBR.050	5705499400106	50	7.8	61.8
801.NBR.075	5705499400113	75	7.8	87.1
801.NBR.110	5705499400120	110	8.9	124.2
801.NBR.125	5705499410815	125	10.2	142.3
801.NBR.160	5705499400137	160	11.5	180.1
801.NBR.200	5705499410822	200	12.8	223.8

SI LIP SEALING TYPE 801

FOR USE IN FIRE-APPROVED PRODUCTS

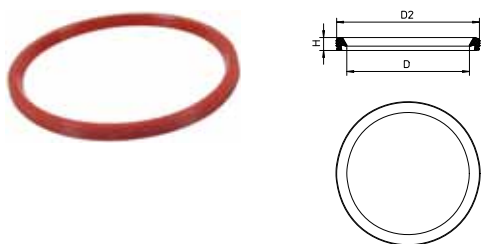

Type no.	EAN no.	D	H	D2
801.SI.050	5705499408140	50	7.8	61.8
801.SI.075	5705499408157	75	7.8	87.1
801.SI.110	5705499408164	110	8.9	124.2
801.SI.160	5705499408171	160	11.5	180.1

for steel decks and bulkheads

PENETRATION TYPE 866

WITH SLEEVE FOR WELDING

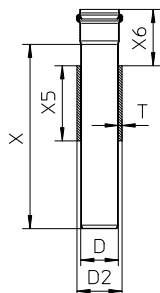

Type no.	EAN no.	EC/MED	D	D2	X	X5	X6	T	Kg
866.025.040.10FS	5705499413267	A0-A60	40	50	250	100	75	5	0,83
866.025.050.10FS	5705499410099	A0-A60	50	60	250	100	75	5	1,00
866.025.075.10FS	5705499411126	A0-A60	75	85	250	100	75	5	1,50
866.025.110.10FS	5705499411140	A0-A60	110	120	250	100	75	5	2,20
866.025.125.10FS	5705499129397	A6-A60	125	135	250	100	75	5	2,63
866.025.160.10FS	5705499411171	A0-A60	160	170	250	100	75	5	3,80
866.025.200.10FS	5705499413328	A0-A60	200	210	250	100	110	5	5,25

PENETRATION FOR WASH BASIN TYPE 866.032

WITH SLEEVE FOR WELDING

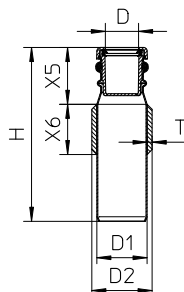

Type no.	EAN no.	D	D1	H.	D2	X5	X6	T	Kg
866.032.050.05 S	5705499403992	32	50	173	60	57	50	5	0,60

Inlet diameter can be changed to D=40mm

TOILET PENETRATION FOR VACUUM SYSTEM TYPE 867

WITH SLEEVE FOR WELDING

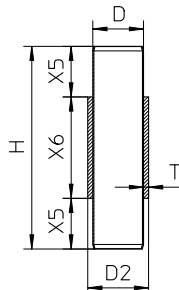

Type no.	EAN no.	EC/MED	D	H.	D2	X5	X6	T	Kg
867.020.040.10 S	5705499413274	A0-A60	40	200	50	50	100	5	0,90
867.020.050.10 S	5705499410549	A0-A60	50	200	60	50	100	5	0,90

for steel decks and bulkheads

FLANGED PENETRATION TYPE 868

WITH FLANGE FOR WELDING

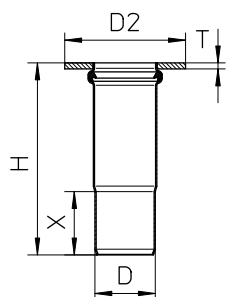

Type no.	EAN no.	EC/MED	D	H.	D2	X	T	Kg
868.100.040FS	5705499413281	A0-A60	40	152	90	50	5	0,36
868.105.050FS	5705499411195	A0-A60	50	159	100	52	5	0,40
868.115.075FS	5705499411218	A0-A60	75	175	135	57	5	0,70
868.125.110FS	5705499411232	A0-A60	110	200	160	74	5	1,00

PENETRATION TYPE 870

WITH SLEEVE FOR WELDING

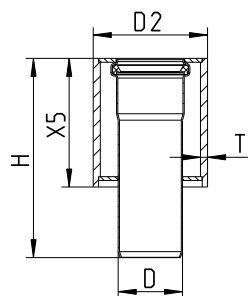

Type no.	EAN no.	EC/MED	D	H.	D2	X5	T	Kg
870.000.040FS	5705499413298	A0-A60	40	151	90	100	5	1,45
870.000.050FS	5705499411256	A0-A60	50	155	90	100	5	1,47
870.000.075FS	5705499411270	A0-A60	75	167	108	100	5	1,74
870.000.110FS	5705499412161	A0-A60	110	167	140	100	4	2,29

Please note! EC/MED approval is for deck penetrations only.

TRANSITION PIECE TYPE 872

WITH SLEEVE FOR WELDING

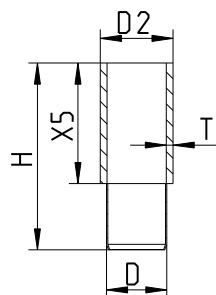

Type no.	EAN no.	EC/MED	D	H.	D2	X5	T	Kg
872.050.040 S	5705499413304	A0-A60	40	150	50	100	5	0,83
872.060.050 S	5705499411348	A0-A60	50	155	60	100	5	0,82
872.076.075 S	5705499411355	A0-A60	75	160	76	100	5	0,99

Continues on next page

for steel decks and bulkheads

TRANSITION PIECE TYPE 872

Type no.	EAN no.	EC/MED	D	H.	D2	X5	T	Kg
Continued from previous page								
872.089.075 S	5705499411362	A0-A60	75	160	89	100	5	1,25
872.114.110 S	5705499411379	A0-A60	110	155	114	100	6	1,77

for aluminium decks and bulkheads

FLANGED PENETRATION TYPE 878

WITH BIMETAL FLANGE FOR WELDING

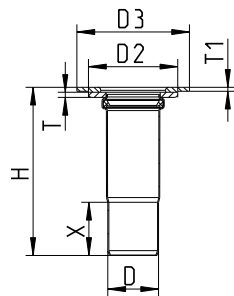

Type no.	EAN no.	EC/MED	D	H.	D2	D3	X	T	T1	Kg
878.105.050 S	5705499121780	A0-A60	50	166	88	110	52	6	4	0,60
878.115.075 S	5705499121803	A0-A60	75	182	113	136	57	6	4	0,86
878.125.110 S	5705499121827	A0-A60	110	207	148	172	74	6	4	1,27

Jointing unit with group penetration for steel decks

Ideal for use e.g. in service spaces near cabin modules for instance in cruise liners, allowing all sanitary units of the cabin to be connected to one fire-approved deck penetration. The jointing unit can be pre-installed in the deck before the

cabin units are fitted, thus avoiding subsequent welding. With all penetrations for connections to and from the cabin in one place, the jointing unit contributes to making inspection and maintenance easy.

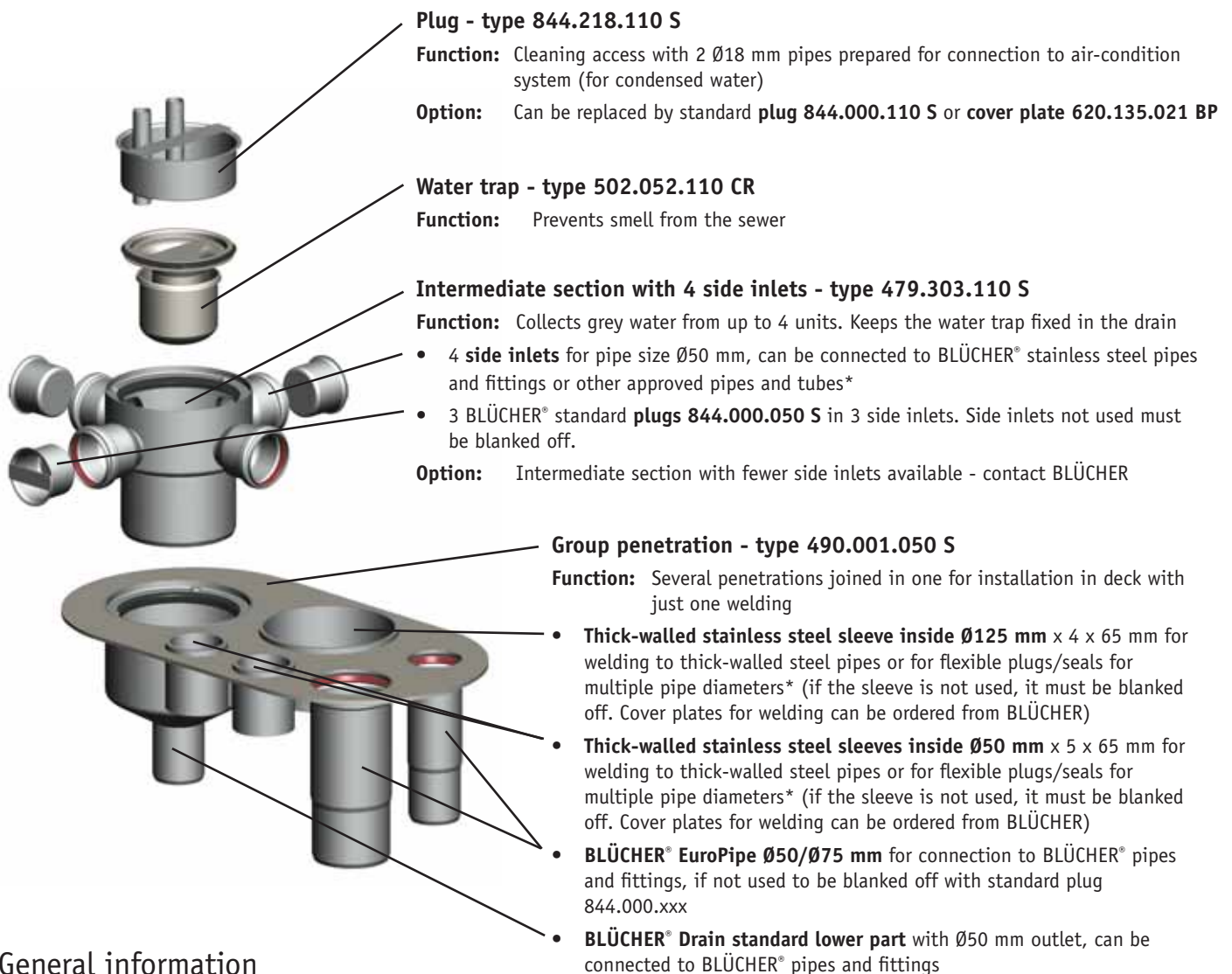

General information

Fire class: A0, A30 and A60

Approval no.: MED-B-5672

Insulation: Please find detailed information regarding insulation in the appendix to the certificate.
 For products in thick-walled sleeve, please contact the supplier

Materials: The jointing unit is made from stainless steel grade AISI 316L and comes with SI and CR rubber sealings for the BLÜCHER® products.

* Fire-approved products which have been tested and approved according to IMO Res. A.754(18)

for steel decks and bulkheads

GROUP PENETRATION TYPE 490

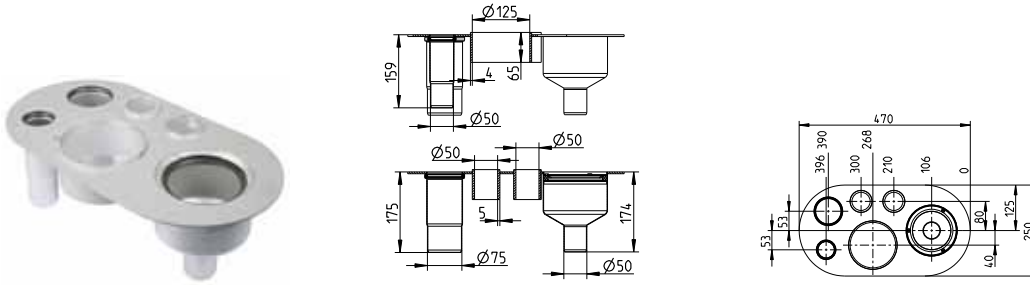

Type no.	EAN no.	EC/MED	Kg
490.001.050 S	5705499127805	A0-A60	4,86

INTERMEDIATE SECTION FOR GROUP PENETRATION TYPE 479

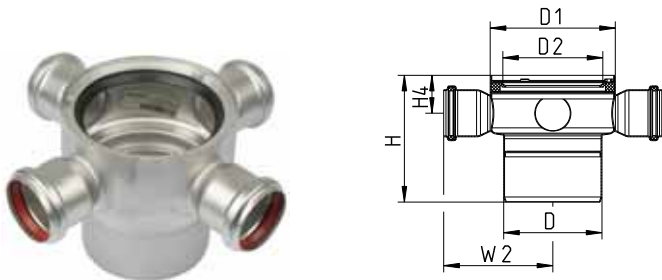

Type no.	EAN no.	D	D1	H	H4	W2	D2	Kg
479.303.110 S	5705499127812	110	140	142	43	122	113	0,92

PLUG FOR GROUP PENETRATION TYPE 844.218

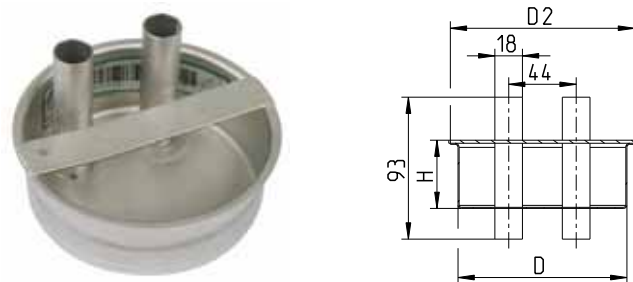

Type no.	EAN no.	D	H	D2
844.218.110 S	5705499127829	110	45	120

MANUAL PIPE CUTTER

Cutting is done by a special disc cutter, which cuts and grips at the same time.

N.B.: Do not cut fittings.



Type no.	EAN no.	Designation
006.050.110	5705499000061	Manual pipe cutter (40 - 110 mm)
006.125.200	5705499001020	Manual pipe cutter (110 - 200 mm)
006.000.005	5705499000023	Spindle for pipe cutter 006.050.110
006.000.000	5705499000016	Cutting disc for pipe cutter 006.050.110
006.000.001	5705499001068	Cutting disc for pipe cutter 006.125.200

ELECTRICAL PIPE CUTTER

Cutting time:
Seconds.

Changeover time:
Changeover from one cutting disc to another can be effected within a matter of seconds.

Cutting quality:
The cutting motion has been developed to produce a bevelled leading edge to cut ends. As a result only the application of BLÜCHER jointing lubricant is required prior to jointing cut ends.

Power supply:
110 Volt/Min 2 kVA/60 Hz or 220 Volt/50 Hz.

Pipe diametres:
50-160 mm

N.B.: Do not cut fittings.



Type no.	EAN no.	Designation
800.050.160	5705499400021	Electrical pipe cutter 220 V
800.050.160 GB	5705499000184	Electrical pipe cutter 110 V, 16 A
800.050.160 US	5705499000191	Electrical pipe cutter 110 V, USA plug
800.030.006	5705499400014	Cutting disc
006.050.160	5705499124132	Support base for electrical pipe cutter

CUTTING OIL/JOINTING LUBRICANT

Jointing lubricant is applied to make jointing a simple action. After a few days the lubricant will dry out and lose its lubricity making subsequent demounting of a joint difficult. If subsequent demounting of joints can be envisaged then we can supply a silicone based lubricant that will not dry out. BLÜCHER jointing lubricant is based on a mild and harmless liquid detergent that is biologically degradable. BLÜCHER cutting oil is recommended for use with BLÜCHER EuroPipe pipe cutters.



Type no.	EAN no.	Designation
007.000.000	5705499000078	Atomizer
007.100.050	5705499000085	Jointing lubricant 0.5 L
007.500.050	5705499000092	Cutting oil 0.5 L

Stainless steel



Type of material

Stainless steel is a clean, durable, corrosion resistant material with a design life expectancy of over fifty years. The BLÜCHER® sanitary discharge system comes in 2 stainless steel grades, AISI 316L and AISI 304. BLÜCHER normally recommends the use of AISI 316L because the risk of corrosion, caused by an aggressive environment, is significantly reduced or eliminated entirely by choosing the molybdenum stainless steel type AISI 316L. Below are listed the recommended type of material for different applications.

Fire resistant

- Non combustible
- No need for special fire insulation
- No toxic fumes released in case of fire

Light-weight

- Low weight - high strength
- Weight only one third of cast iron
- Larger pipes are easily handled by one man

Hygienic

- Low surface roughness
- High flow capacity
- No bacterial growth
- No blockages

Long life time

- Corrosion resistant
- Resistant to impact damages
- Resistant to temperature fluctuations

In some products, in which part components are used that are not exposed to sewage water and consequently not affecting the functionality or lifetime of the product, these part components may be made from other materials or alloys than specified for the complete products.

During installation and until test/normal operation the sanitary discharge system is to be closed and not used in order to avoid contamination by corrosive substances.

Black water piping	Grey water piping	Grey water piping, Galleys	Deck drain piping	Outside piping visible
AISI 316L (AISI 304)	AISI 316L (AISI 304)	AISI 316L	AISI 316L*	AISI 316L**

* Pipes to be flushed regularly with fresh water

** Outside piping must be primed and painted

Material properties stainless steel

What is stainless steel?

The designation stainless steel covers a wide range of alloys with different properties. One property common to all stainless steels is that they contain at least 12% chromium.

The stainless steels can be divided into three main groups and a few mixed types according to the structure of the steel:

- Austenitic stainless steel
- Ferritic stainless steel
- Martensitic stainless steel

Austenitic stainless steel is the most important, representing approx. 90% of total stainless steel consumption. Austenitic steel is also the only stainless steel suitable for drainage installations, and it is, of course, the type used by BLÜCHER.

Importance of alloying elements

Austenitic stainless steel contains at least 18% chromium and 8% nickel – thus the well-known designation »18/8« steel. Corrosion resistance generally increases with increasing content of chromium. In alloys with 12-13% chromium, the passive layer is strong enough to prevent the steel from corroding in normal or mildly aggressive media. The main effect of the alloying element nickel is on the structure of the steel and its mechanical properties. The steel's structure is austenitic with an adequate content of nickel. In contrast to the pure chromium steels (ferritic stainless steel), this results in significant changes in the mechanical properties, such as increased workability and ductility, better resistance to thermal stress and improved weldability. The austenitic structure also results in a change in the physical properties of the steel. For example, the steel is not magnetic.

Nickel also increases resistance to corrosion caused by certain

media. Molybdenum has the same effect on the structure as chromium, but it also has a strongly positive influence on corrosion resistance. Molybdenum-containing steel is normally designated »acid-resistant« because of the resistance of these steels to certain types of acids. But acid-resistant stainless steel will also have limited resistance to some media such as chlorine-containing media (see table of resistances).

Why is steel »stainless«?

The addition of chromium to the steel results in the building up of a passivating oxide film with a high content of chromium oxides. This oxide film protects the surface of the steel against oxygen in air and water.

An outstanding property of stainless steel is that the chromium oxide film automatically regenerates if the surface of the steel is exposed.

This restitution of the oxide film can only occur if the surface of the steel is completely clean and free of tempering agents and slag from welding processes and residues from tools made from ordinary carbon steel.

If this surface contamination is not removed, the steel may ultimately corrode. To prevent this, the steel surfaces should be cleaned after welding and processing, e.g. by means of so-called acid pickling of the stainless steel.

The pickling effectively removes all impurities from the surface of the steel and permits the reestablishment of a strong, uniform chromium oxide film. The pickling bath normally consists of 0.5-5% v/v HF (hydrofluoric acid) and 8-20% v/v HNO₃ (nitric acid) at a temperature of 25-60°C. This acid bath removes residues, the existing chromium oxide film and traces of iron, leaving the clean steel surface. The restitution of a strong chromium oxide film starts in the subsequent rinsing in water.

Material Specification

Material	AISI 316L 1.4404	AISI 304 1.4301
Analysis		
Carbon (C %)	Max. 0,03	Max. 0,07
Chromium (Cr %)	16,5 - 18,5	17,0 - 19,0
Nickel (Ni %)	11,0 - 14,0	8,5 - 10,5
Molybdenum (Mo %)	2,0 - 2,5	-
Manganese (Mn %)	Max. 2,0	Max. 2,0
Silicium (Si %)	Max. 1,0	Max. 1,0
Sulphur (S %)	Max. 0,030	Max. 0,030

Physical Properties

Structure	Austenitic (nonmagnetic)	Austenitic (nonmagnetic)
State	Non-annealed	
Specific gravity (g/cm ³)	7,98	7,9
Melting point (°C)	Ca. 1400	Ca. 1400
Decortication temperature in air (°C)	800 - 860	800 - 860
Expansion coefficient 20 - 100 °C (m/m · °C)	16,5 • 10 ⁻⁶	16,5 • 10 ⁻⁶
Specific resistance (20° C) (Ohm · mm ² /m)	0,75	0,73
Heat conductivity (20°C) (W/°C-m)	15	15
Specific heat (J/g · k)	0,5	0,5

Mechanical Properties

Ultimate tensile strength (Rm) (N/mm ²)	490 - 690	500 - 700
Yield point (Rpo2) (N/mm ²)	190	195
Modulus of elasticity (E) (20° C) (N/mm ²)	2,0 • 10 ⁵	2,0 • 10 ⁵
Hardness Brinell (HB) (N/mm ²)	120 - 180	130 - 180

Material properties stainless steel

Corrosion resistance

Austenitic chromium-nickel steel is resistant to many different chemical products and most detergents. BLÜCHER® drainage products are manufactured exclusively from this group and as such are suitable for use within the food, beverage, chemical, pharmaceutical, dairy, shipbuilding and commercial catering industries.

When increased acid-resistance is required, and spot and crevice corrosion may occur, or in general for marine/off-shore use, molybdenum-alloyed chromium-nickel steels (AISI 316L) may be used.

These acid-resistant steels resist a number of organic and inorganic acids.

However, acid-proof steels are only partially resistant to solutions containing chlorides.

Impact resistance

The high tensile strength of stainless steel makes the material resistant to impact damage at all temperatures. Severe blows to the material may in certain cases cause dents, they are however unlikely to fracture the material.

Fire resistance

Stainless steel is non-combustible which means that pipes and drains made of stainless steel may penetrate deck/bulkhead partitions without the need for special fire insulation (e.g. intumescent fire collars). Furthermore, no toxic fumes or substances are released from stainless steel in the event of fire.

Thermal stress

Due to the very low heat expansion coefficient of stainless steel, BLÜCHER® drainage products are not adversely affected by temperature fluctuations occurring in drainage installations. Consequently, there are no special constraints that determine at what temperature BLÜCHER® products should be stored or installed.

Hygiene

Hygiene is an important issue, in particular on cruise vessels. From practical experience in hygienic installations (food preparation, health care etc.) it is documented that bacterial growth on stainless steel is significantly lower than on alternative materials (e.g. plastics). In addition an unused piece of stainless steel pipe has a very low surface roughness ($K=0.00006$ in. (0.0015 mm)). This low surface roughness minimises not only bacterial growth, but also the danger of sediments building up which may later lead to blockages.

Weight

BLÜCHER® drainage products are all produced in thin-walled stainless steel sheet making the most of the material's high strength to weight ratio.

This makes our product the superior choice when calculating the weight optimisation for the vessel or off-shore installation in question.

CHEMICAL RESISTANCE TABLE

The table is based on laboratory experiments with chemically pure substances. The values should therefore be regarded as for guidance only.

	A = Very good service to operating limit of material B = Moderate service C = Limited or variable service D = Unsatisfactory				
	ASTM 316 L Stainless	ASTM 304 Stainless	EPDM	NBR	FPM
Acetone	A	A	A	D	D
Acetic acid (dilute.) 30% or 50%	A	A	A	B	B
Acetic acid 100%	A	A	A	C	C
Acetic anhydride	A	A	B	C	D
Aluminium chloride	D	D	A	A	A
Aluminium sulfate	A	D	A	A	A
Ammonium carbonate	A	A	A	D	-
Ammonium chloride/salmiac	B	C	A	A	-
Ammonium hydroxide	A	A	A	D	B
Amyl chloride	A	A	-	-	-
Aniline	A	A	B	D	C
Anilin hydrochloride	D	D	B	B	B
Barium chloride	B	B	A	A	A
Barium hydroxide	A	A	A	A	A
Benzaldehyde	A	A	A	D	D
Benzene	A	A	D	D	A
Benzoic acid	A	A	-	-	A
Borax/sodium borat	A	A	A	B	A
Boric acid	A	A	A	A	A
Bromine	D	D	-	-	A
Bromine chloride	D	D	A	B	A
Bromoethylene/vinyl bromide	A	A	-	-	-
Butanol	A	A	D	A	A
Butyl acetat	A	A	B	-	D
Butyric acid	A	A	-	-	-
Calcium bisulfate	A	A	D	A	A
Calcium chloride	B	B	A	A	A
Calcium hydroxide	A	A	A	A	A
Calcium hypochlorite	B	C	A	C	A
Carbon disulfide	A	A	-	-	-
Carbon tetrachloride	A	A	D	C	A
Chloroacetic acid (Mono)	D	D	B	-	-
Chlorine (dry)	A	A	-	-	A
Chlorobenzene	A	A	D	D	A
Chlorosulfonic acid	B	C	D	D	C
Copper chloride	B	B	A	A	A
Copper nitrate	A	A	-	-	-
Copper sulfate	A	A	A	A	A
Ether	A	A	-	-	-
Ethyl chloride	A	A	A	A	A
Fatty acid	A	A	D	B	A
Fluorine (dry)	A	A	-	-	-
Hydrofluoric acid	D	D	B	D	A
Formaldehyde	A	A	A	B	A
Formic acid	A	A	A	B	C
Furfural	A	A	B	D	D
Gallic acid	A	A	B	B	A
Hydrobromic acid	D	D	A	D	A
Hydrochloric acid	D	D	A	D	A
Hydrogen peroxide	A	A	C	D	B
Iodine (wet)	D	D	-	-	-
Kloroform	B	B	D	D	A
Lead acetate	A	A	A	B	-
Magnesium chloride	B	B	A	A	A

VALUES TO BE REGARDED AS FOR GUIDANCE ONLY

	A = Very good service to operating limit of material B = Moderate service C = Limited or variable service D = Unsatisfactory				
	ASTM 316 L Stainless	ASTM 304 Stainless	EPDM	NBR	FPM
Magnesium sulfate	A	A	A	A	A
Mercury	A	A	A	A	A
Methanol	A	A	A	A	C
Methyl chloride	A	A	C	D	A
Methylene chloride	B	B	D	D	B
Natphalene	A	A	D	D	A
Nickel chloride	B	B	A	A	A
Nickel sulfate	A	A	A	A	A
Nitric acid	C	C	C	D	A
Oxalic acid	C	C	A	B	A
Perchloric acid	D	D	B	-	A
Phosphoric acid	A	A	B	D	A
Picric acid	A	A	B	B	A
Potassium bromide	A	A	-	-	-
Potassium carbonate	A	A	-	-	-
Potassium chlorate	A	A	-	-	-
Potassium cyanide	A	A	A	A	A
Potassium hydroxide	A	A	A	B	B
Potassium nitrate	A	A	A	A	A
Potassium permanganate	A	A	-	-	-
Potassium sulfate	A	A	A	A	A
Potassium sulfide	A	A	-	-	-
Potassium chloride	B	B	A	A	A
Propylene dichloride	A	A	-	-	-
Silver nitrate	A	A	A	B	A
Soda (ash)/sodium	A	A	-	-	-
Sodium acetate	A	A	A	B	D
Sodium bicarbonate	A	A	A	A	A
Sodium bisulfate	A	C	-	-	-
Sodium bisulfite	A	A	A	A	A
Sodium bromide	B	B	-	-	-
Sodium chlorate	A	A	-	-	-
Sodium chloride	D	D	-	-	-
Sodium cyanide	A	A	A	A	A
Sodium fluoride	A	A	-	-	-
Sodium hydroxide	A	A	A	B	B
Sodium hypochlorite	D	D	B	B	A
Sodium nitrate	A	A	A	B	-
Sodium sulfate	A	A	A	A	A
Sodium sulfide	A	A	-	-	-
Sodium sulfite	A	A	-	-	-
Stannous chloride/tin chloride	B	C	B	A	A
Sulfur	A	A	A	D	A
Sulfur chloride	A	A	D	C	A
Sulfur dioxide	A	B	A	D	A
Sulfuric acid	D	D	B	D	A
Sulfurous acid	A	C	B	B	A
Thionyl chloride	A	A	D	-	A
Toluene/toluol	A	A	D	D	A
Trichloroethylene	A	A	D	C	A
Turpentine	A	A	D	A	A
Xylene/xylol	A	A	-	-	-
Zinc sulfate	A	A	-	-	-

VALUES TO BE REGARDED AS FOR GUIDANCE ONLY

Assumptions: 20°C room temperature

References

Corrosion Data Survey, 1969 Edition, Nace
Corrosion Tables, Stainless Steels, 1979, Jernkontoret
Chemical Resistance of Plastic Piping Materials, Cabot Corporation, 1979

PLEASE NOTE!

Concentration level, length of exposure, temperature and in particular the combination of several chemicals have a direct influence on the resistance of stainless steel to certain chemicals.

Each application should therefore be carefully reviewed to determine the suitability of stainless steel.

In particular, be careful with the use of hydrous cleaning agents containing compounds of chlorine.

Material properties rubber seals

Rubber types

International designation	EPDM	NBR	FPM	SI
Rubber type	Ethylene propylene	Nitrile	Fluorine (Viton®)	Silicone
Nominal hardness IRHD	60 (+/-5)	60 (+/-5)	60 (+/-5)	57 (+/-5)
Colour	Black	Black/yellow dot	Purple	Red
Tensile strength MPa	≥ 10 N/mm ²	≥ 10 N/mm ²	≥ 8 N/mm ²	≥ 5,5 N/mm ²
Elongation after fracture %	≥ 300%	≥ 300%	≥ 260%	≥ 250%
Max. temperatur range	-35/+100° C	-30/+80° C	-25/+200° C	-50/+230° C
Colour	Black	Black	Purple	Red

Resistance

Wearability	2	2	2	-
Resistance to mineral oil	5	1	1	3
Resistance to vegetable oil	2	1	1	1
Resistance to gasoline	5	1	1	5
Resistance to aromatic compounds and hydrocarbons	5	2	1	3
Resistance to ketones	1	5	4	3
Resistance to ordinary diluted acids and alkalines	1	1	1	2
Resistance to ozone and weather stresses	1	3	1	1
Resistance to air diffusion	4	3	1	2

1 = Very good 2 = Good 3 = Moderate 4 = Limited service 5 = Low

BLÜCHER sealing rings are available in four different rubber qualities.

EPDM This sealing ring is black and made of ethylene propylene rubber. This is BLÜCHER's standard sealing ring and it is suitable for all rainwater and waste water installations where there is no oil or no petrol residues in the waste water.
The EPDM lip seal is a good all-round rubber quality suitable for a wide range of applications.

NBR This sealing ring is black with a yellow spot and made from nitrile rubber and is the sealing ring to be used where there are petrol or oil residues on the waste water (e.g. in association with oil and petrol separators at service stations, garages etc.).
The NBR lip sealing ring should not be used where there is a risk of temperatures above 80°C. NBR is not resistant to solvents.

FPM This sealing ring is purple and made from fluorine rubber (Viton®).
This is BLÜCHER's sealing ring for special applications. The material is particularly heat-resistant and resistant to oil, solvents and strong acids. However, the FPM seal has only limited resistance to e.g. butyl acetate, acetone and methyl alcohol.

SI This sealing ring is red and made from silicone rubber (VMQ). This is the BLÜCHER sealing ring used for fire safety. The SI sealing ring is only used in BLÜCHER's special fire resistant pipe penetrations.

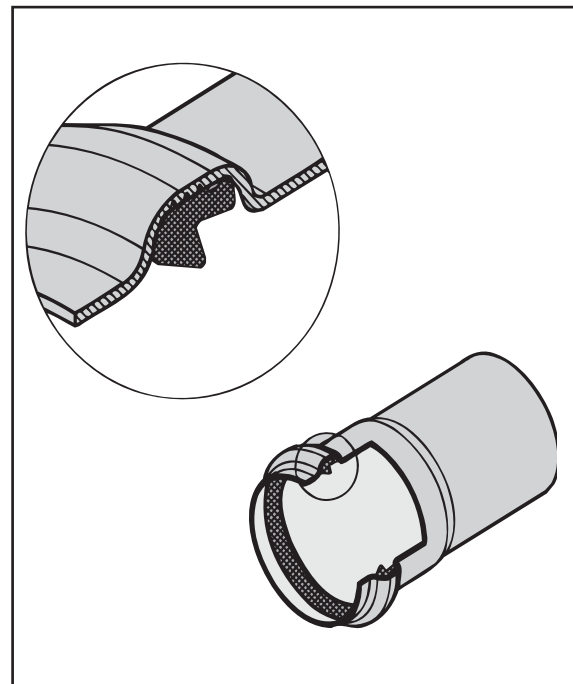

For advice regarding the suitability of the different rubber qualities, consult BLÜCHER.

Measure conversion table

The below table states the general dimensions etc. of the BLÜCHER® sanitary discharge system converted into inch/ft./psi

Pipe sizes						
mm	050	075	110	125	160	200
inch	1,96	2,95	4,33	4,92	6,30	7,87

Pipe lengths										
mm	150	250	500	750	1000	1500	2000	4000	5000	6000
ft.	0,5	0,8	1,6	2,5	3,3	4,9	6,6	13,0	16,4	19,7

Drain outlets				
mm		050	075	110
inch		1,96	2,95	4,33

Acceptable vacuum							
mm		050	075	110	125	160	200
bar		- 0,85	- 0,85	- 0,60	- 0,60	- 0,60	- 0,60
psi		- 12,3	- 12,3	- 8,70	- 8,70	- 8,70	- 8,70

Acceptable pressure* (for installations fixed with pipe hangers)							
mm		050	075	110	125	160	200
bar		+ 0,50	+ 0,50	+ 0,50	+ 0,50	+ 0,50	+ 0,50
psi		+ 7,25	+ 7,25	+ 7,25	+ 7,25	+ 7,25	+ 7,25

- * Gravity
OD 50 - 200 mm + 0,50 bar
- * With joint clamps
OD 50, 75, 110 mm + 2,00 bar
OD 125, 160 mm + 1,00 bar
- * With projections
and joint clamps
OD 50, 75, 110, 125, 160 mm + 3,00 bar

1 mm	=	0,03937 inch
1 m	=	3,281 ft.
1 bar	=	14,504 psi

Maintenance

With the right choice of material, a BLÜCHER® sanitary discharge system can be used for most types of drainage installations requiring little maintenance, provided that a few precautions are taken during installation and operation.

During installation

During installation care must be taken to prevent contamination of the stainless steel by carbon steel in tools or otherwise touching the stainless steel. In itself, carbon steel will not cause corrosion of the stainless steel surface, but the carbon steel particles adhering to the stainless steel will rust and cause discolourings. Always use clean tools suitable for stainless steel without any adhering iron shavings or particles or rust, stainless steel wool/brushes and stainless steel brackets, screws, bolts, nuts, etc. in the stainless steel drainage system.

If welding, or use of carbon steel tools or similar is to take place close to a stainless steel installation, the stainless steel surface is to be protected until the work has been completed.

To prevent construction waste or chemicals used in connection with other construction work from being admitted to the sanitary discharge system during installation and completing of other construction work, it is very important to keep the sanitary discharge system closed and unused until all construction work has been completed.

All BLÜCHER® Marine drains lower parts come with a welding cover to ensure protection of the drainage system during installation. The sanitary discharge system must also be thoroughly cleaned and flushed on completion to ensure that any blockages or leaking joints are revealed before the sanitary system is put into use.

In operation

On delivery from BLÜCHER, all stainless steel surfaces have been passivated and are perfectly clean. In other words, the stainless steel has formed a corrosion-resistant oxide film over the entire surface.

To preserve the outstanding anti-corrosion properties of the stainless steel, surface contamination and deposits are to be prevented. The general rule is to clean the steel when it becomes dirty, which dependent on the environment- may be at intervals from 1 to 4 times each year. Highly polluted (industrial atmosphere) or salty air (marine conditions) as well as deposits of chlorine-containing cleaning agents or acid may cause discolourations and corrosion on lower grade stainless steel, but the risk of corrosion is considerably reduced or eliminated if grade AISI 316L is chosen for the installation.

Stainless steel is resistant to a wide range of chemicals and substances, but a few guidelines are to be observed as regards what substances can be discharged through the system:

Waste water containing substances that may cause deposits of sludge or solids such as sand, plaster or iron shavings may cause damage to the drainage system

Waste water containing chemicals to which the stainless steel is not resistant, e.g. hydrochloric acid, may cause corrosion. Modern cleaning processes use many chemicals, but care should be taken to ensure that the cleaning agent is suitable for stainless steel. Mechanical cleaning might be used as well. Contact the manufacturer of the cleaning agent if in doubt.

Prevent blockages by regularly flushing of the drainage system through drains and water traps and through other rodding access. Blockages owing to fat discharged through kitchen sinks may be prevented by using a grease separator.

Installation videos at www.blucher.com

As a supplement to the printed installation instructions for the BLÜCHER® products used in marine applications, the following installation videos are available at www.blucher.com (select the tab "Installation"):

BLÜCHER® EuroPipe
Cutting of pipes with electrical pipe cutter



BLÜCHER® EuroPipe
Cutting of pipes with manual pipe cutter



BLÜCHER® EuroPipe
Introduction to use and applications



BLÜCHER® Drain Marine
Installation in decks



BLÜCHER®

At BLÜCHER® more than 300 employees create an annual turnover of more than 50 million euro.

Through know-how, dedicated service and common sense we develop, produce and market high quality stainless steel drainage solutions for customers within the housing, commercial, industrial and marine sectors all over the world.

Find your local BLÜCHER® specialist at www.blucher.com

BLÜCHER® EuroPipe

BLÜCHER® Channel

BLÜCHER® Drain



KEEPING UP THE FLOW